

PowerDIN 4PZ

MANUAL

FIRMWARE 3.2.6
and later

27.4.2023

Table of Contents

Introduction.....	3
1 Safety notices.....	3
2 General characteristics.....	4
3 Specifications.....	5
3.1 Features.....	6
3.2 Drawings.....	8
3.3 Device description.....	9
3.4 LED and button functions.....	10
LED indicators.....	10
SETUP button (under the top plate).....	10
3.5 Minimum system requirements (for configuration).....	10
3.6 Package contents.....	11
4 Configuration and control.....	11
4.1 Connecting PowerDIN 4PZ to LAN.....	11
4.2 Connecting PowerPDU 4PZ to a local WiFi (AP Mode).....	12
4.3 NETIO Mobile2.....	15
4.4 Detecting and configuring the IP address.....	16
4.5 Static IP.....	17
4.6 Login to device web.....	18
4.7 Restoring factory defaults.....	19
4.8 Controlling the output manually.....	19
5 Web interface.....	20
5.1 Outputs.....	20
5.1.1 Outputs - Energy measurements.....	22
5.1.2 Outputs - General.....	25
5.1.3 Outputs - Schedule.....	27
5.2 Inputs.....	28
5.2.1 Digital Inputs - Status and SO Counters.....	28
5.2.2 Inputs - General.....	29
5.3 M2M API Protocols.....	30
5.3.1 M2M API Protocol - XML over HTTP.....	31
5.3.2 M2M API Protocol - JSON over HTTP.....	37
5.3.3 M2M API Protocol - URL API (http get).....	42
5.3.4 M2M API Protocol - Telnet.....	44
5.3.5 M2M API Protocol - Modbus/TCP.....	49
5.3.6 M2M API Protocol - MQTT-flex.....	54
5.3.7 M2M API Protocol - Netio Push.....	58
5.3.8 M2M API Protocol - SNMP.....	60
5.4 Cloud.....	64
5.5 PAB.....	67
5.6 Watchdogs.....	68
5.7 Rules.....	70
5.8 Users.....	71
5.9 Schedules.....	72
5.10 Settings.....	75
5.10.1 Wi-Fi.....	75
5.10.2 Network Configuration.....	76
5.10.3 Date / Time.....	80
5.10.4 Firmware.....	81
5.10.5 System.....	83
5.11 Log.....	85
6 DECLARATION OF CONFORMITY (RED CE).....	87
7 Products overview.....	88
8 Product features.....	89

Introduction

Thank you for purchasing this product of NETIO products a.s. Before using your product, please read this **User Manual (MAN)** and the included **Quick Installation Guide (QIG)** to avoid problems with incorrect installation or use.

Caution:

The product works with mains voltage. Mishandling may damage it or result in injury or death.

1 Safety notices

NETIO PowerDIN 4PZ connects directly to a 230VAC supply; therefore, it should be installed by qualified personnel only!

1. Never remove the device cover if the relay terminals are connected to the power grid!
2. The local electrical system must include a power switch or a circuit breaker and overcurrent protection.
3. The manufacturer is not liable for any damage caused by incorrect use of the device or by operating it in an unsuitable environment.
4. The device is not rated for outdoor use.
5. Do not expose the device to strong vibrations.
6. Unauthorized modifications may damage the device or cause a fire.
7. Protect the device from liquids and excessive temperatures.
8. Make sure the device does not fall.
9. Only electrical appliances approved for use with the electrical network may be connected to the device.
10. Do not connect multiple devices in series.
11. The cable plug must be easily accessible.
12. The device is completely switched off only when unplugged.
13. If the device malfunctions, disconnect it from the electrical outlet and contact your vendor.
14. Do not cover the device.
15. Do not use the device if it appears to be mechanically damaged.
16. Make sure that the input and output cables are rated for the respective current.

2 General characteristics

- Metered outputs: 2 channels
- Digital Outputs: 4 in total
- DO Metered power outputs switching element: 2x Relay + ZCS (Out 1, 2: SPST-NO) - Max 16A
- DO Relay outputs switching element: 2x Relay (Out 3, 4: NO/NC) - Max 2A
- DI (Digital Inputs): 2 (dry contact) + S0 counter (4 bytes)
- LAN interface 10/100 Mbps (RJ-45)
- WiFi interface: 802.11 b/g/n; 2.4GHz (secured / unsecured), internal antenna
- WiFi encryption: WEP, WPA, WPA2
- AP mode for connecting the device to a local WiFi network (network selected from a list)
- Built-in web server for device configuration and control
- Password-protected login into device configuration
- Electricity consumption metering on two channels: [V, Hz, A, W, Wh, TPF, °]
- Measurement accuracy <1%
- ZCS (Zero Current Switching)
- IOC (Independent Output Control)
- PowerUp state - (ON / OFF / LAST)
- Overvoltage protection
- Operating temperature range: -20°C to +55°C
- Supported protocols: DNS, NTP, DHCP, HTTP, uPNP
- Supported M2M protocols: Modbus/TCP, Telnet, SNMP, MQTT, Http Push, XML, JSON, URL API

3 Specifications

Power	100-240 V; 50/60 Hz; 16 A
DO Metered power outputs	2x, 16 A total / 16 A per output (Out 1, 2)
Surge protection	Type 3 (CAT III)
DO Power Output relays	Micro-disconnection (μ) (resistive load), SPST-NO 1E5 switching cycles, max. 1.5 kV pulse voltage Switch heat and fire resistance class 1 ZCS (Zero Current Switching)
Electrical load	ZCS (Zero Current Switching) - Resistance load compatible - Capacitive load compatible - Inductive load compatible
DO Relay outputs switching element	2x Relay (Out 3, 4: NO/NC) - Max 2A
DI (Digital Inputs)	2x Dry contact input with 50 impulse counter (32bits, non resetable)
Terminal blocks	Wire range: 2.5mm ² (22-14AWG) Torque: 0.5Nm (4.4Lb-In) Strip length: 5-6mm
Network interfaces	1x Ethernet RJ-45 10/100 Mbit/s 1x Wi-Fi IEEE 802.11 b/g; 2.4GHz
Internal consumption	Max 2W
Environment	IP30, protection rating = class 1 Operating temperature -20°C to +55°C Device rated for pollution degree 2. Designed for continuous operation in altitudes up to 2000 m. Does not require additional cooling

3.1 Features

ZCS (Zero Current Switching)

ZCS (Zero Current Switching) function ensures that the relay contact is closed at the moment of zero voltage and opened at the moment when zero current flows through it.

Closing and opening at these exact moments has a number of advantages:

- The negative effects of inrush current on the lifetime of the relay in the NETIO device are significantly reduced.
- Reduced probability of a circuit breaker tripping in the circuit branch where the appliance with a high inrush current is connected.
- Significantly improved lifetime of switching supplies in appliances that are connected to the socket (especially in case of frequent switching on and off).
- Significantly reduced electromagnetic interference caused by repeated switching on and off.

Zero current switching (ZCS) significantly improves the lifetime of the NETIO device and the connected end devices. This function is particularly important in case of frequent switching.

Note: ZCS is only for Output 1 and Output 2 (metered and switched power outputs).

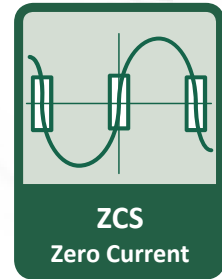

IOC (Independent Output Control)

Independent Output Control function of the NETIO device uses an independent system that ensures a stable operation of the output even if the main system is being restarted, updated, or is booting.

Thanks to IOC, the controlled output can power devices that, for technical reasons, must be powered without interruption (such as servers). The output control is completely independent from the WiFi or LAN communication subsystem.

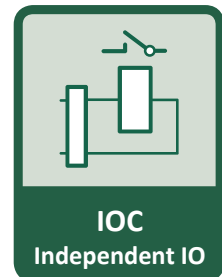

PowerUp State

The PowerUp State parameter (sometimes also called **Cold start**) defines the behavior of the 110/230V power output during the first milliseconds to seconds after powering up the device, before the LAN/WiFi communication with a master system is established.

For some applications, it is important to set the correct state of a power output immediately after power is turned on (or restored). With servers in particular it is important to avoid undesired momentary switching.

Possible settings for NETIO device

- On
- Off
- LAST state restores the last state before the power was disconnected

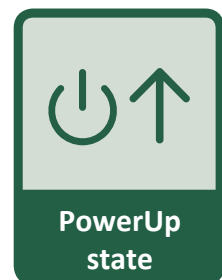

Electrical measurements

PowerDIN 4PZ measures relevant electrical parameters.

Parameter	Range	Units	Resolution	Accuracy
Voltage	90,0 - 250,0	V	0,1	<1%
Frequency	45,0 - 65,0	Hz	0,1	<1%
Current	0,005 - 16,000	A	0,001	<1%
TPF (True Power Factor)	0,00 - 1,00	-	0,01	<1%
Phase	0 - 360	°	0,01°	<1%
Output power	0 - 3600	W	1	<1%
Energy	0 - 4294967296	Wh	1	<1%
Reverse Energy	0 - 4294967296	Wh	1	<1%

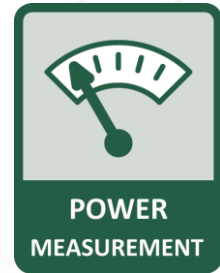

Quick WiFi connection setup (AP mode installation)

- NETIO PowerDIN 4PZ creates a WiFi network that you connect to with your PC or mobile phone.
- It then scans for WiFi networks in the vicinity, and lets you choose from a list and type the password.
- NETIO PowerDIN 4PZ then confirms the connection to the network and displays the assigned IP address.
- NETIO devices can be discovered in the LAN using the [NETIO Discover](#) tool.



3.2 Drawings

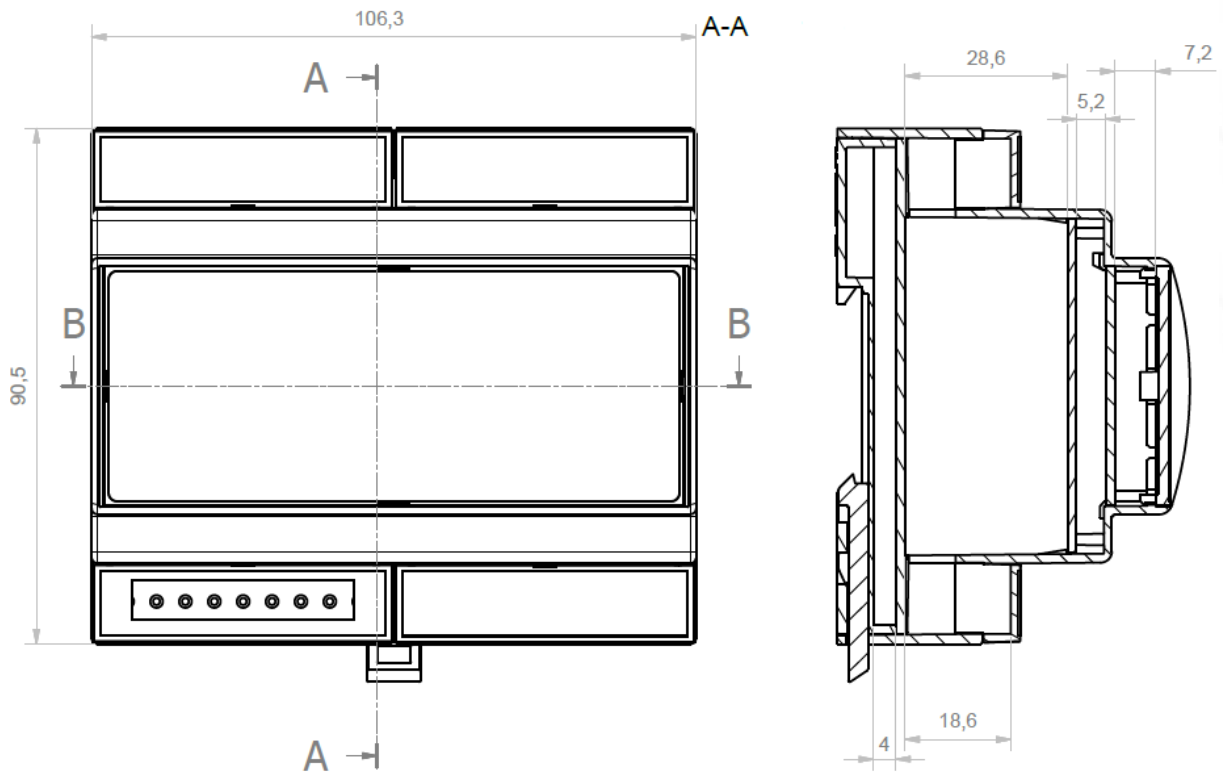

Figure 1 - PoweDIN 4PZ front and side view (millimeters)

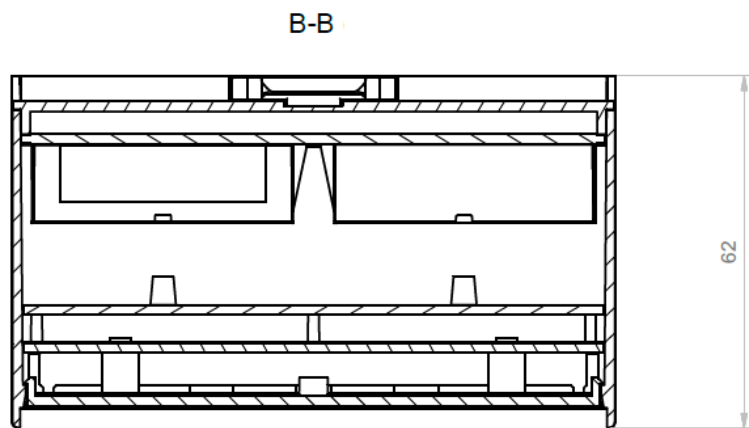

Figure 2 - PoweDIN 4PZ cut view (millimeters)

3.3 Device description

1. 1x RJ45 LAN jack
2. LEDs (OUTPUTS, INPUTS, M2M and WiFi)
3. RJ45 LEDs – Ethernet states (yellow and green)
4. "SETUP" button (under plastic plate with green label)
5. 230V Input and Outputs terminal blocks
6. Output relay terminal blocks
7. Digital Inputs terminal block

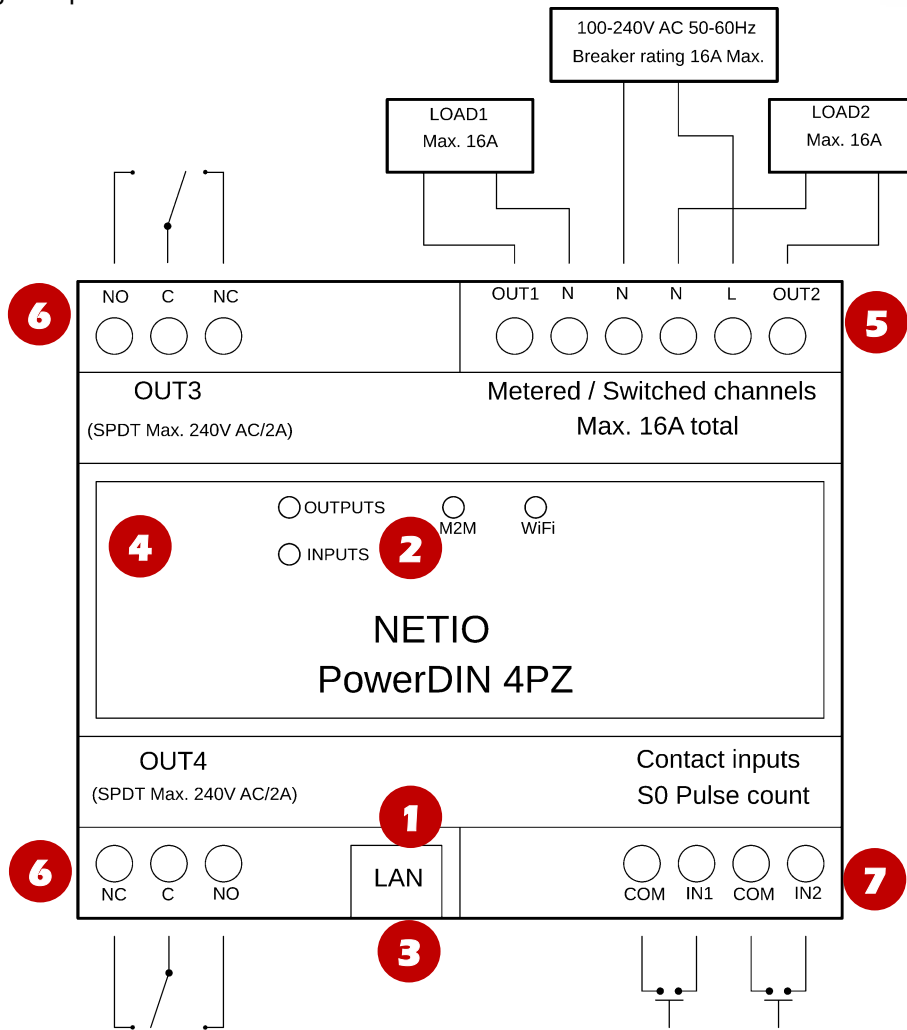

Figure 3 - PoweDIN 4PZ description

SN (serial number) on the label

-----xx
24A42C38E9EA

WiFi network in AP mode:

PowerDIN-AP-xx

PowerDIN-AP-EA



Figure 4 - PoweDIN 4PZ SN label

3.4 LED and button functions

LED indicators

OUTPUTS (green)	Light when at least one Output is ON. Blink when Output state change.
INPUTS (green)	Blink when some Input state change
M2M (red)	Blink when some M2M communication is in progress. Communication with NETIO Cloud included (if Cloud enabled). (communication of WEB administration or Mobile app is not indicated)
WiFi (yellow)	Light when connected to WiFi
RJ45 LEDs (green and yellow)	Ethernet Link and Activity

SETUP button (under the top plate)

Remove the top plate with green label - the button "DEFAULT" is on the left side.

Restoring factory defaults	Disconnect the device from the power. Press and hold the button. Connect the device to the power grid (button is pushed) and wait at least 10 seconds. After green LED OUTPUTS blinks, release the button. The device reverts to factory settings and the AP mode is activated (if no Ethernet cable connected).
----------------------------	---

3.5 Minimum system requirements (for configuration)

A device with an Internet browser (Firefox, Chrome, Safari, Microsoft Internet Explorer, Opera, Mozilla etc.) that has JavaScript and cookies enabled.

3.6 Package contents

- NETIO PowerDIN 4PZ
- Quick Installation Guide (QIG)



Figure 5 - PoweDIN 4PZ package

4 Configuration and control

NETIO PowerDIN 4PZ can use the Ethernet connection (RJ45) or WiFi connection to network. The description of connection options below (LAN or WiFi) apply for the new devices or devices after “Restoring factory defaults”.

Connect the NETIO PowerDIN 4PZ device to the power grid using the terminal blocks.

4.1 Connecting PowerDIN 4PZ to LAN

- Connect your NETIO device to a LAN with a network cable (RJ45).
- Wait about 30 seconds until the device starts and address is provided from a DHCP server. If your network doesn't have DHCP server continue to section [Static IP](#). The WiFi is completely turned off in this case.
- Continue in section [Detecting and configuring the IP address](#)

4.2 Connecting PowerPDU 4PZ to a local WiFi (AP Mode)

WiFi is enabled only if Ethernet cable is not connected!

- When the device is powered up for the first time, it enters the “AP mode” (Yellow WiFi LED flashing quickly).
- Connect from PC, tablet or smartphone, to WiFi “PowerDIN-AP-xx” (Figure 6).
- Device configuration page should open automatically. If not, open a web browser and enter <http://10.0.42.1> You will see NETIO PowerDIN 4PZ WiFi configuration page. (Figure 7).

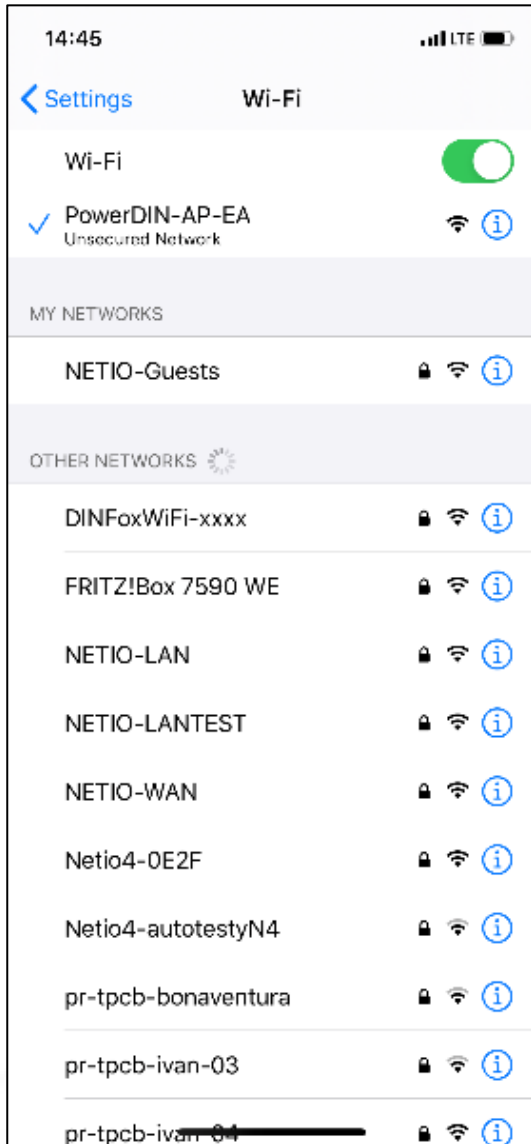

Figure 6 - Connecting to PowerDIN 4PZ AP

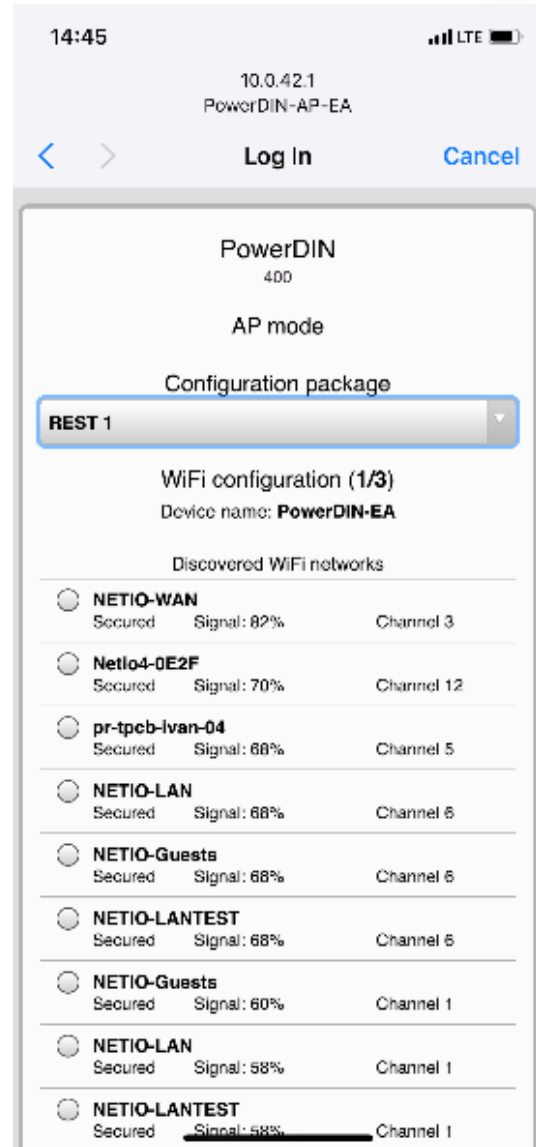

Figure 7 - Web Interface in AP mode

- Select your network in the list of detected networks and click “Next” (Figure 8).
- Enter the password for the selected WiFi network. You may also change the device name. If your network does not use DHCP, unselect this option and manually enter the IP address and other network parameters (Figure 10; for experts only). Click “Next” to confirm (Figure 9).

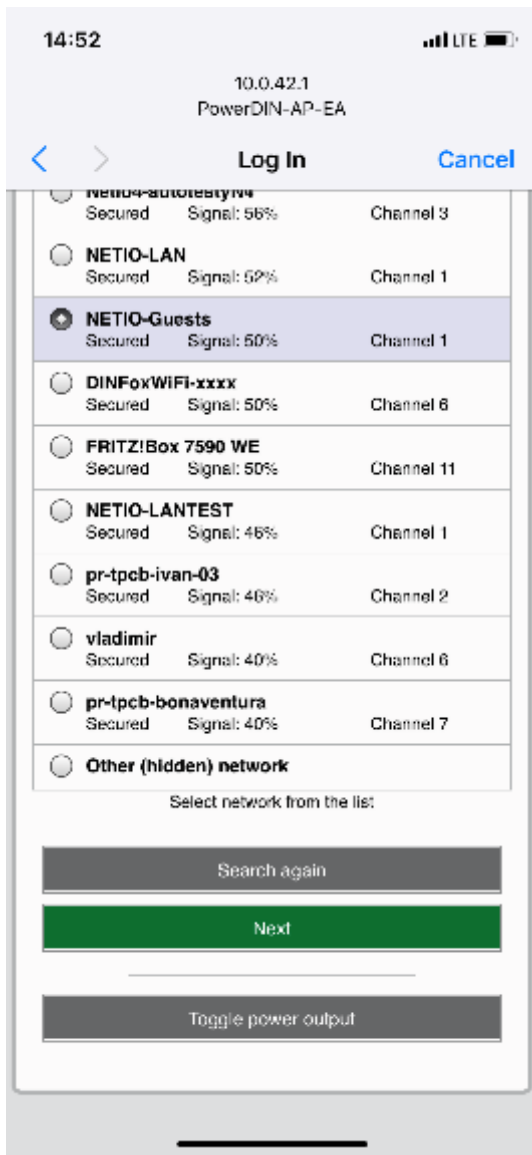

Figure 8 - Network selection in AP mode

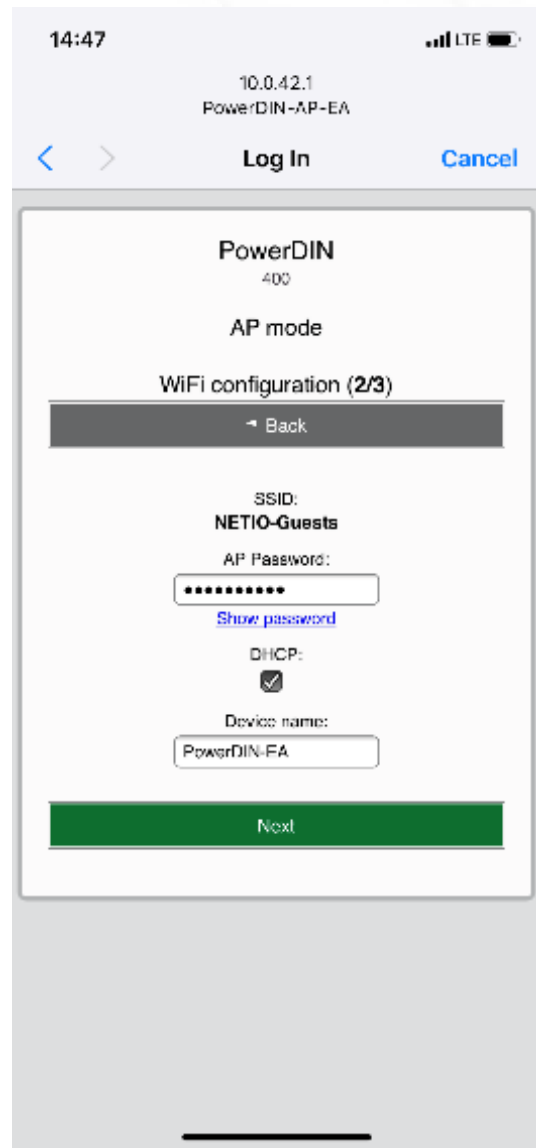
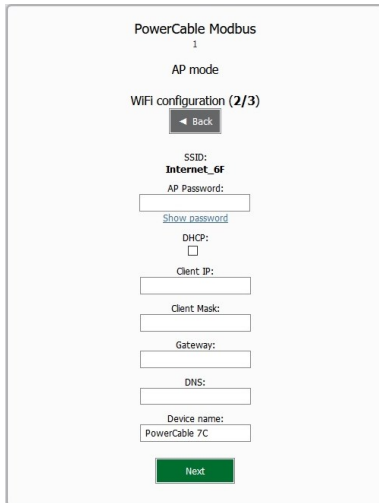

Figure 9 - Connecting to Wi-Fi in AP mode



If you do NOT use a DHCP server in your network, set the following parameters:

- AP Password - password for the network to which the PowerDIN 4PZ will be connected
- Client IP - IP address in your network address range
- Client mask - network mask for your network
- Gateway - gateway for your network
- DNS - DNS server for your network or a public DNS, e.g. 8.8.8.8
- Device name - specify a name under which the PowerDIN 4PZ will be visible in the local network

For more information, see chapter 5.6 Network Configuration

Figure 10 - Configuring the network IP parameters

- A page with the connection result is displayed. If it shows “WiFi status: Connected“, check the network parameters and then click “Save&Connect” to save the configuration (Figure 11). The device then exits the AP mode, connects to the selected WiFi network, and displays a network configuration summary page (Figure 12). WiFi connection is indicated with the yellow LED.

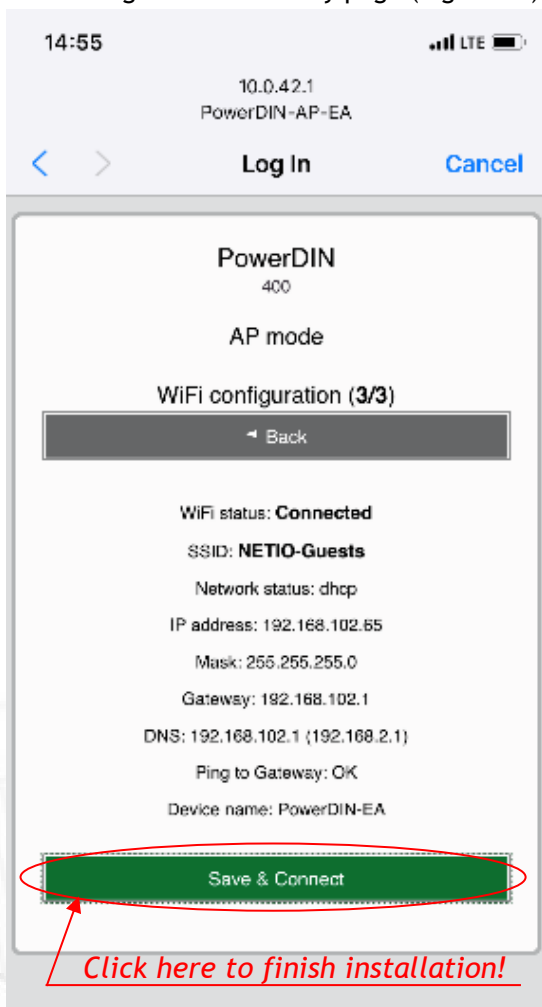

Figure 11 - Configured Wi-fi parameters

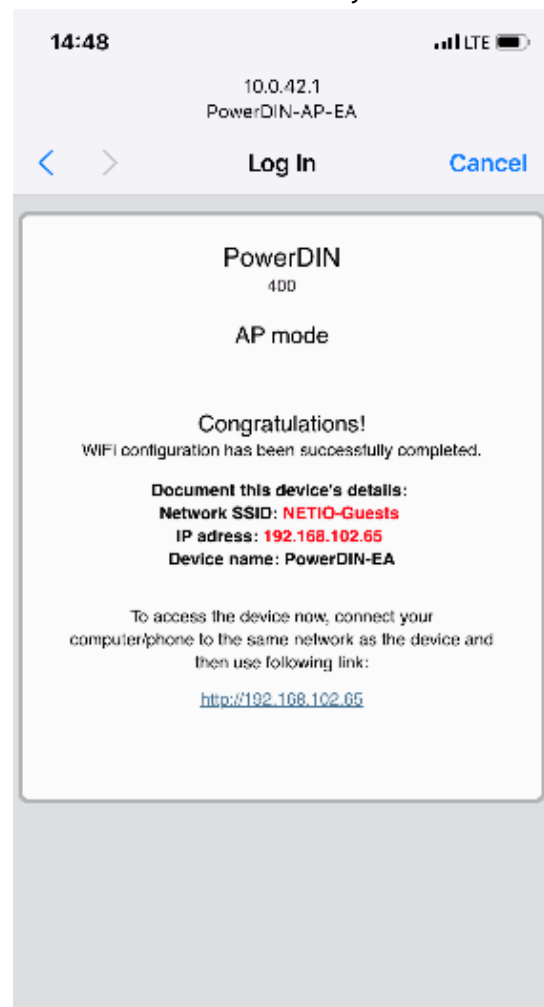

Figure 12 - Network connection info

4.3 NETIO Mobile2

NETIO Mobile2 application is for control NETIO devices produced after 2016.

Features:

- Switch On / Off / Restart each power socket/output through local network or NETIO Cloud.
- Show power consumption on each power output (if supported by device).
- Grouping and sorting of the power outputs and the group control (Switch On / Off all outputs in group).
- Searching NETIO devices in local network.
- Add devices from NETIO Cloud.

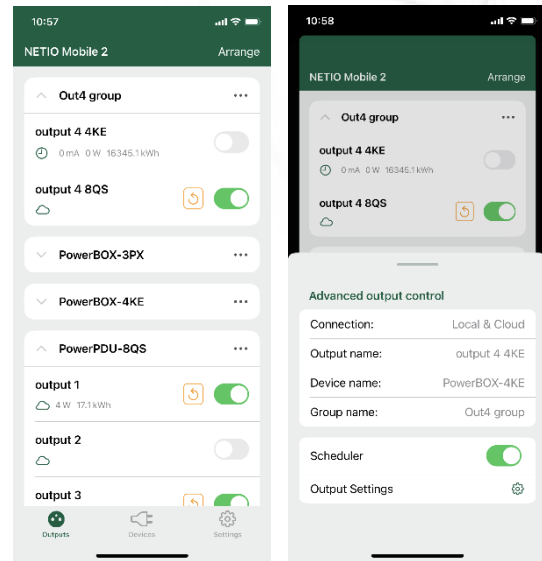

You can use NETIO Mobile 2 application for Android or iOS to discover the local network and find NETIO devices there. Make sure your mobile device is connected to the same network as NETIO device.

1. Start NETIO Mobile 2 app.
2. Android: Touch on “+” in the right bottom corner.
iOS: Touch on “+ Add device” on the “Devices” page.
3. Touch “FIND DEVICES”. The list of all discovered NETIO devices will appear (displaying name, MAC, IP Address).
4. Android: Select the device and touch “CONNECT”.
iOS: Touch the device you’d like to add.
5. the device name, username and password and touch “Connect”.

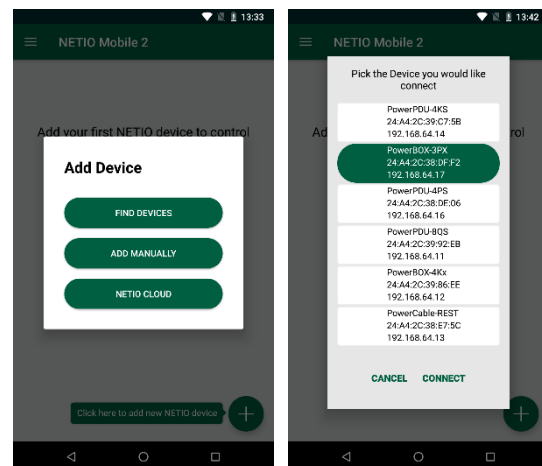

<https://play.google.com/store/apps/details?id=cz.netio.netio>



Android



<https://apps.apple.com/cz/app/netio-mobile-2/id1619326833>



iOS

4.4 Detecting and configuring the IP address

If you have followed the instructions in the previous chapter, you know the NETIO device's IP address, whether it was assigned by a DHCP server or configured manually. If you forgot the IP address, or if you have received a pre-configured device, you will need to find out its IP address.

Use Windows based NETIO Discover utility, available for download at <http://www.netio-products.com/en/software/netio-discover>.

Depending on your operating system, choose the .exe file (Windows) or the .jar file (Linux or Mac). To run the .jar file, JAVA RE is needed. It is available at: www.java.com

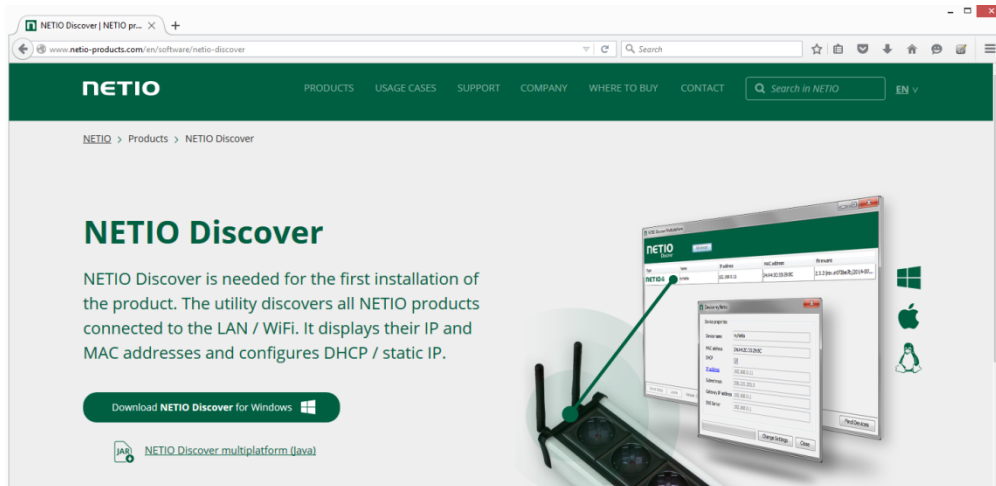

Figure 13 - NETIO Discover web interface

To successfully discover the IP address, the controlling system must be in the same LAN as the NETIO device.

If the discovered IP address belongs to a different address range than that of your WiFi network, we recommend resetting the device to factory defaults (see chapter [Restoring factory defaults](#)) and then configuring it according to chapter [Configuration and control](#).

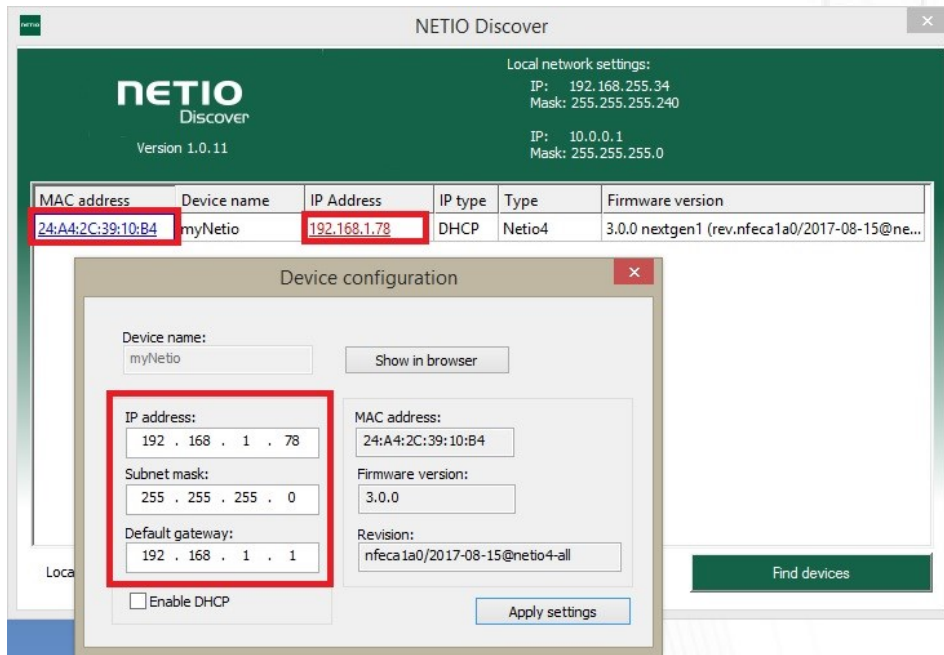

Figure 14 - Discovering and configuring network parameters using NETIO Discover

The IP address can't be changed and is only for view!

Enter the IP address into a web browser or the NETIO Mobile app and log in to the device.

Note: For MAC or Linux users use the NETIO Discover Multiplatform version.

4.5 Static IP

If no DHCP server is available on the network you can use following procedure to activate “Static IP mode”:

- Connect the device to LAN, power and switch it on.
- Wait at least 30sec and then press and hold the “TGL/RESET” button for min 10sec. until yellow status LED flashes.
- The device switches to the “Static IP mode” with IP address 192.168.1.78
- Open the WEB interface using <http://192.168.1.78> and log in from computer connected to the same network (or directly to device) and with IP from the same subnet (e.g. 192.168.1.10 mask 255.255.255.0).
- Go to [Settings / Network Configuration](#) and select “Set static IP address”, set up IP, mask, GW and click “Save Changes”. If not modified and not saved by clicking “Save Changes” the device will use DHCP after the next restart (power off/on) unless the device has been already configured for static IP address before entering the “Static IP mode”.

4.6 Login to device web

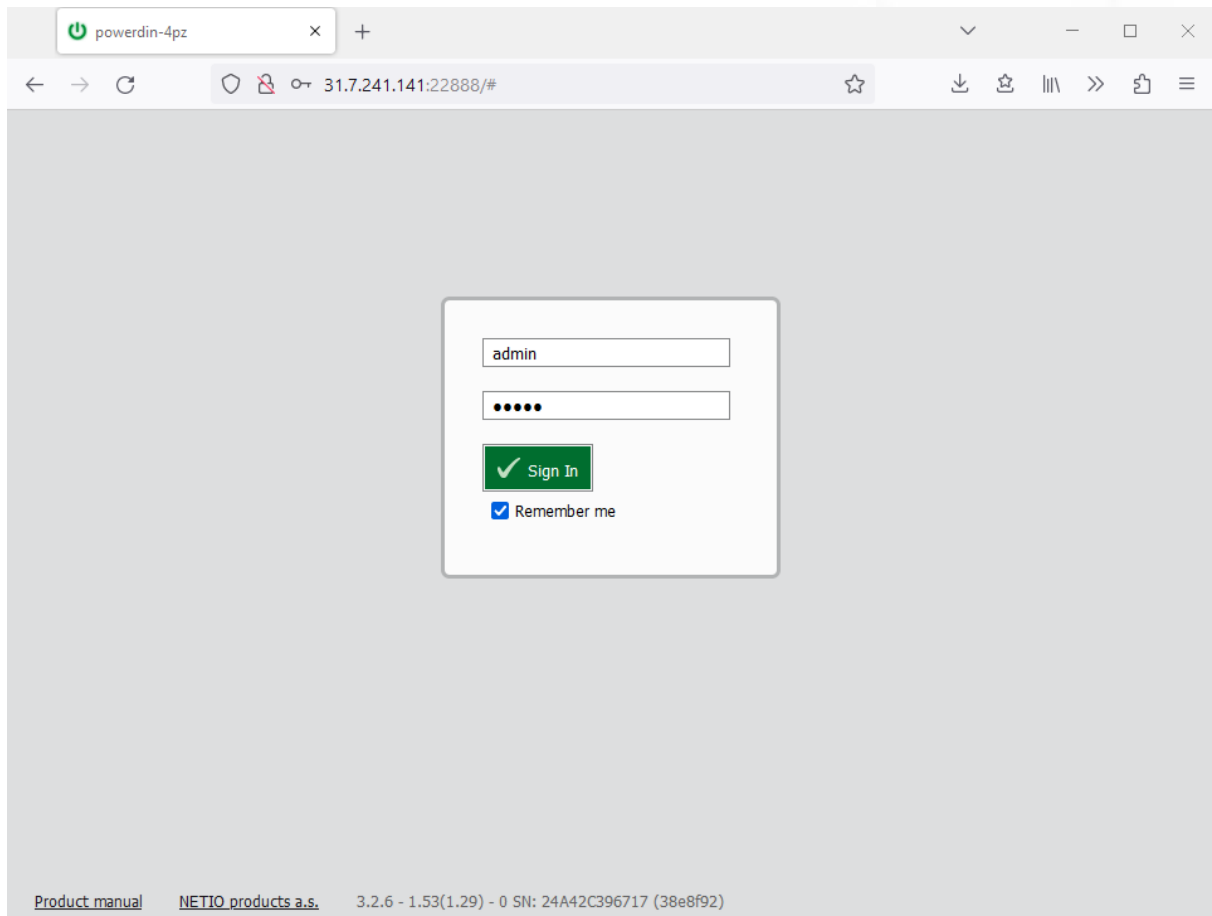

Figure 15 - PowerDIN 4PZ login dialog

To log in, use **admin / admin**
(default login username / password)

4.7 Restoring factory defaults

This operation deletes all user settings and restores the configuration to the factory defaults. It is useful when the device is in an unknown state or does not behave as described in this manual.

Procedure:

1. Turn off the PowerDIN 4PZ.
2. Remove the top plate with green label - the button "DEFAULT" is on the left side.
3. Press and hold the button.
4. Connect the device to the power grid (button is still pushed) and wait at least 10 seconds. After green LED OUTPUTS blinks, release the button.
5. The device reverts to factory settings and the AP mode is activated (if no Ethernet cable connected).



Forgotten password

The reset to factory defaults is also used when the password has been forgotten. After restoring the factory defaults, the username and password to access the PowerDIN 4PZ will be "admin" / "admin".

4.8 Controlling the output manually

The outputs can be switched on/off (toggled) by pressing the button quickly 3 times in a row.

The use of this feature is recommended only for troubleshooting etc.

1. Remove the top plate with green label - the button "DEFAULT" is on the left side.
2. Press the "DEFAULT" button three times fast to toggle the outputs.

Note: If at least one output is ON the "toggle" by button change all outputs to OFF. If all outputs are OFF the "toggle" change all to ON.



5 Web interface

5.1 Outputs

In the left menu, click **Outputs**. A screen showing the output appears. The output can be controlled directly with two buttons:

The screenshot shows the 'PowerDIN 4PZ' web interface. The left sidebar is expanded to 'Outputs'. The main area displays four output controls, each with a numbered icon (1-4), a green 'ON' toggle switch, and a power symbol. To the right of each control, detailed statistics are shown, including Load, Current, Voltage, Power factor, Phase, Frequency, Energy, and Reverse Energy. A summary section at the bottom provides 'All outputs' totals for load, current, phase, voltage, frequency, and energy. The footer contains product information and a version number.

Figure 16 - Controlling the output

The  ON/OFF button controls the output directly. When the output is on, the button is green; when the output is off, the button is grey . When switching the output off, a confirmation dialog appears:

Do you really want to turn off output_1?

Turn Output Off

Cancel

Don't ask me again

Click **Turn Output Off** to confirm the switch-off or **Cancel** to keep the output switched on.

To suppress this dialog in the future, check **Don't ask me again**.

The  **Reset** button switches the output off and then back on. It is active only when the output is On. A confirmation is requested before the action is performed. The function is enabled only when the output is switched on. When the output is switched off, the Reset button is disabled.

Do you really want to reset output_1?

Reset

Cancel

Don't ask me again

Click **Reset** to confirm the action or **Cancel** to cancel it.

To suppress this dialog in the future, check **Don't ask me again**.

The  **Scheduler** button enable/disable a Scheduler feature for the specific output. Details and setting are described below at chapter [Outputs - Schedule](#).

5.1.1 Outputs - Energy measurements

PowerPDU 4PZ measures the following electrical parameters every 500ms for Output 1 & 2. The values in the web interface are updated every 5 seconds.

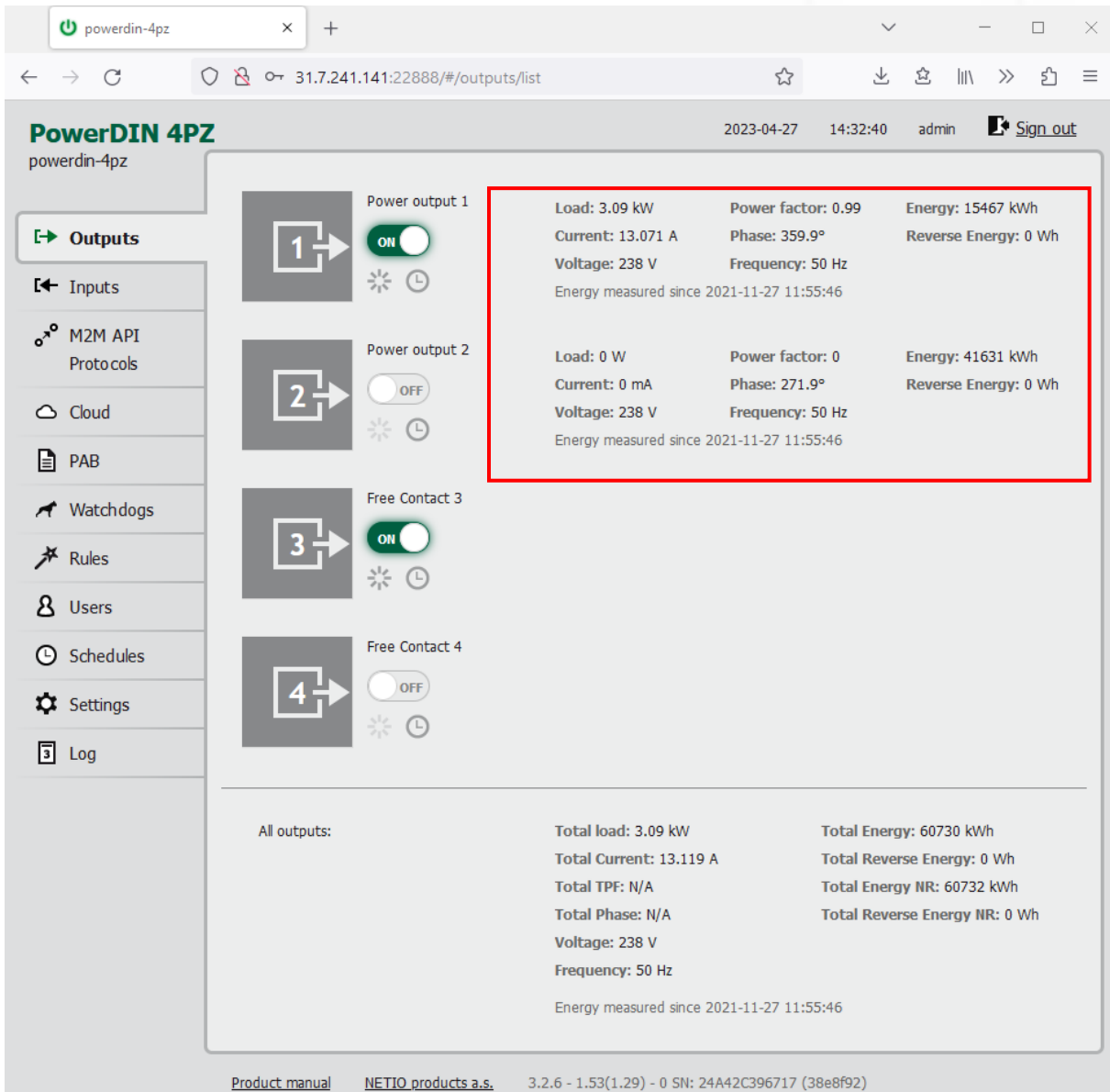

Figure 17 - Measured values

Load in watts [W] corresponds to the immediate current and voltage ($P = U * I * TPF$). It respects the direction - positive value if the connected device consume the energy or negative value if the connected device deliver the power back to the power grid (e.g. solar power system).

Current in amps [A] shows the immediate current flowing through the output. Always positive value.

Voltage in volts [V].

TPF (True Power Factor) shows the ratio of active and apparent power, or the ratio of resistance and impedance. TPF is the ratio of the active power to the apparent power at the power outlet. TPF shows what portion of apparent power is converted by the load to active power. TPF can be viewed as the sum of useful power and losses. TPF, unlike PF (Power Factor), also takes into account non-sinusoidal waveforms. Such distortions of the sinusoidal waveform are caused e.g. by switching power supplies.

Phase in degrees (°) is the value of a phase shift between current and voltage. Depends on a load type connected to output. The value 0° / 360° means resistive load type.

Frequency in hertz [Hz].

Energy in watt-hours (Wh / kWh) is the cumulative energy consumed over a time interval. The value is the total consumption at the output since the last reset of the counter.

Reverse Energy in watt-hours (Wh / kWh) is the cumulative energy delivered back to grid over a time interval. The value is the total power supply at the output since the last reset of the counter.

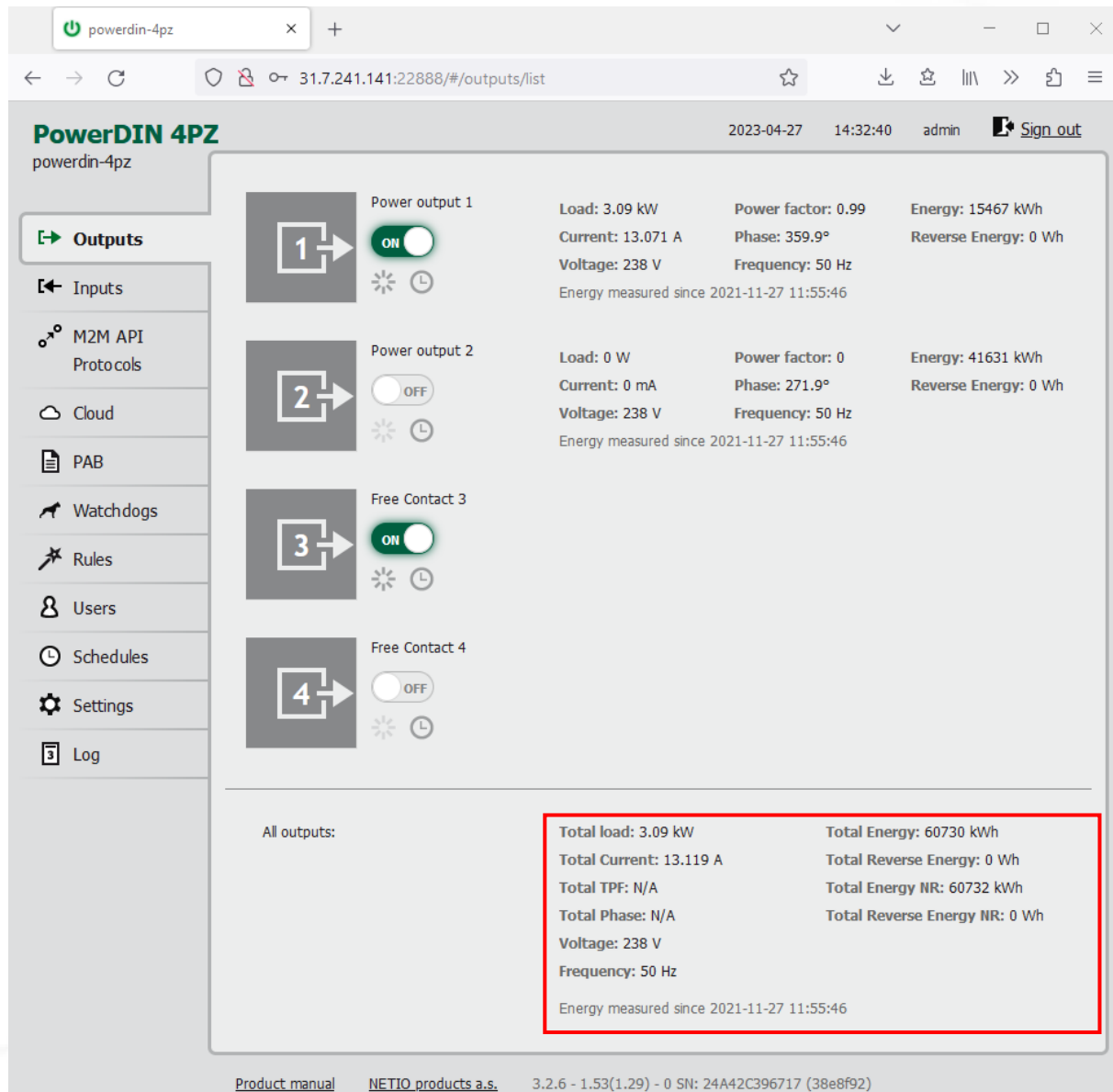

Figure 18 - Measured values - All outputs

All outputs (measured Output 1 & 2) section contains values calculated for the whole device so these apply for the power input cable/connection. Values showing N/A are not available for this type of device. The “Total Energy NR” and “Total Reverse Energy NR” are the non-resettable (NR) counters counting energy since the device has been manufactured and first powered on.

By default, the cumulative Energy consumption/delivery and Total Energy consumption/delivery are counted from the time the NETIO device was first powered on. To reset all Energy counters, go to the **Settings** > **System** tab and click the **Reset Power Consumption Counters** button (see Figure below). This restarts the measurements as of the current moment and the date/time shown change.

The screenshot shows the web interface for a PowerDIN 4PZ device. The browser address bar shows the URL `31.7.241.141:22888/#/settings/system`. The page title is "PowerDIN 4PZ" and the user is logged in as "admin". The left sidebar contains navigation options: Outputs, Inputs, M2M API Protocols, Cloud, PAB, Watchdogs, Rules, Users, Schedules, Settings (selected), and Log. The main content area is titled "System" and displays various configuration options. The "Reset Power Consumption Counters" button is highlighted with a red box. Other visible buttons include "Locate", "Restore Factory Defaults", "Export configuration", and "Import configuration". The "Save Changes" button is green and has a checkmark icon. The "Restart period" is set to 30 minutes. The "Uptime" is 2 days 13 hours 13 minutes. The "Firmware version" is 3.2.6 - 1.53(1.29) - 0 SN: 24A42C396717. The "Device name" is "powerdin-4pz" and the "HTTP port" is "22888".

Figure 19 - Resetting the consumption counter

5.1.2 Outputs - General

Click the picture of the output to open detailed settings.

The  **General** tab configures basic parameters for controlling the output.

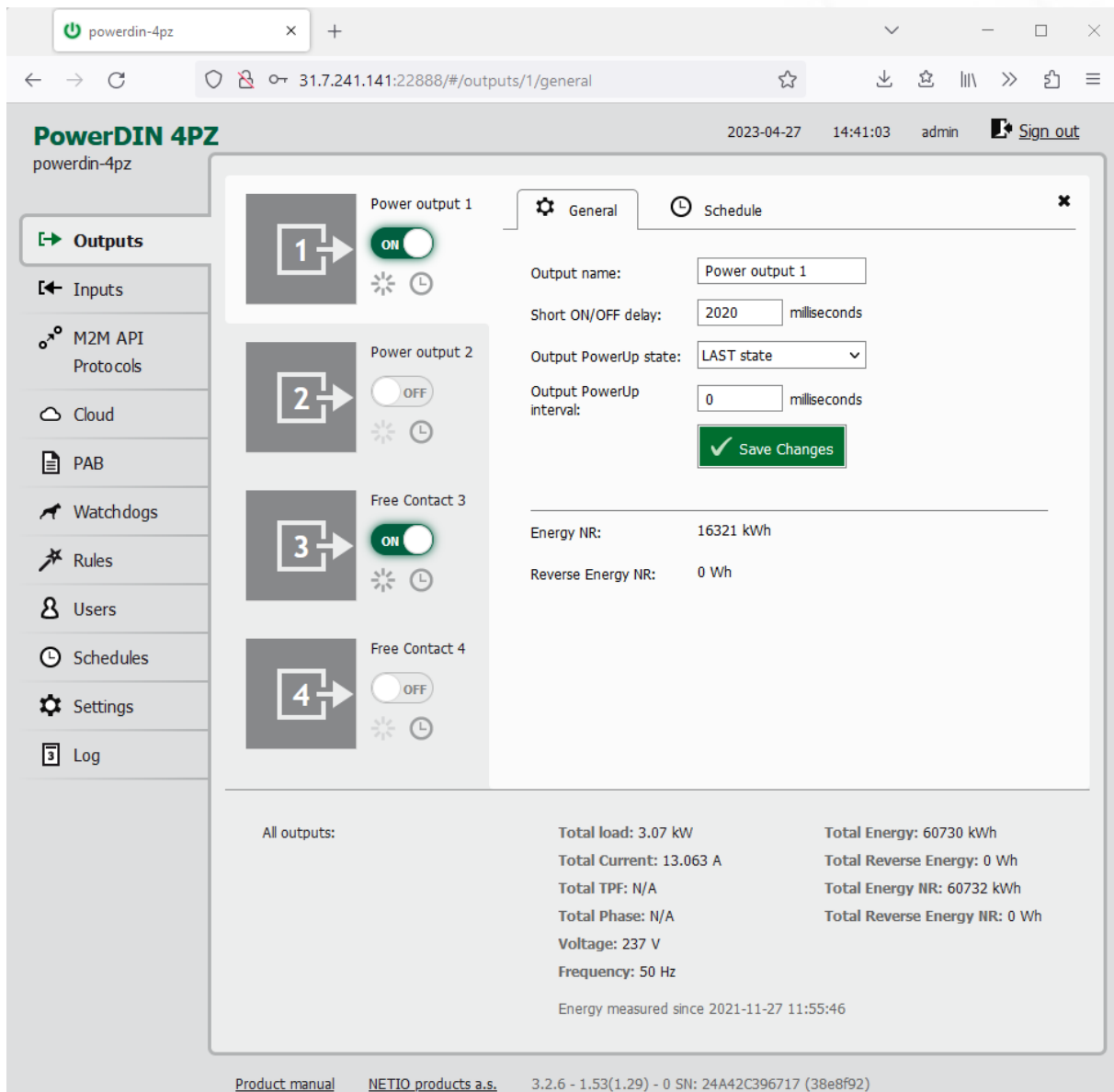

PowerDIN 4PZ 2023-04-27 14:41:03 admin [Sign out](#)

powerdin-4pz

powerdin-4pz

Power output 1 **ON**

Power output 2 **OFF**

Free Contact 3 **ON**

Free Contact 4 **OFF**

General Schedule

Output name: Power output 1

Short ON/OFF delay: 2020 milliseconds

Output PowerUp state: LAST state

Output PowerUp interval: 0 milliseconds

Energy NR: 16321 kWh

Reverse Energy NR: 0 Wh

All outputs:	Total load: 3.07 kW	Total Energy: 60730 kWh
	Total Current: 13.063 A	Total Reverse Energy: 0 Wh
	Total TPF: N/A	Total Energy NR: 60732 kWh
	Total Phase: N/A	Total Reverse Energy NR: 0 Wh
	Voltage: 237 V	
	Frequency: 50 Hz	
	Energy measured since 2021-11-27 11:55:46	

[Product manual](#) [NETIO products a.s.](#) 3.2.6 - 1.53(1.29) - 0 SN: 24A42C396717 (38e8f92)

Figure 20 - General output configuration

Output name is shown above the two control buttons to improve clarity.

Short ON/OFF delay is an integer specifying, in milliseconds, the duration for the Short OFF (power cycling) and Short ON actions.

During this interval, any attempts to switch the output state via M2M API protocols are ignored.

Output PowerUp state defines the state of the output whenever the device is powered up or restarted. The output can be switched on (ON), switched off (OFF), or set to the last state before the restart (LAST).

Warning: The PowerUp setting is ignored if the Scheduler is enabled for specific output.

Output PowerUp interval defines the interval in milliseconds after which the power output is turned on since the power is turned on (e.g. after the power outage). It is only applied if the "Output PowerUp state" is set to "ON" or "LAST" and the Output was on before.

Minimum value “Output PowerUp interval” is 0 ms (from start of internal logic - almost immediately after power up).

Maximum value of “Output PowerUp interval” is 43 200 000 ms = 12h.

Energy NR in watt-hours (Wh / kWh) is the cumulative energy consumed since the device has been manufactured. This counter cannot be resetted. **Only PowerPDU 4KS and 8QS shows this value.**

Reverse Energy NR in watt-hours (Wh / kWh) is the cumulative energy delivered back to grid since the device has been manufactured. This counter cannot be resetted. Click **Save Changes** to save the settings.

To close the configuration dialog, click the  symbol in the top right corner.

5.1.3 Outputs - Schedule

The  Scheduler function can be used to switch the output on and off at specified times. Select a schedule to specify when the output should be turned on. After selecting a schedule, the on-times for the output according to that schedule are shown graphically. Check **Enable schedule** if you want enable scheduler and Click **Save Changes** to confirm changes. If the Scheduler is enabled the current interval is applied so the output state may change according to selected schedule.

The displayed schedule cannot be changed in the Output - Schedule view. To change a schedule, click **Edit schedules**. It opens the main tab Schedules (details in chapter [Schedules](#)).

To enable or disable the Scheduler for a given output, you may also click the  Scheduler button next to that output. When the Scheduler function is disabled, the outputs stay in their current states. When it is enabled, the outputs are set according to the schedule.

The  Scheduler button / icon next the output indicates Enabled (green) or Disabled (grey) Scheduler function.

Note: When the Scheduler feature is Enabled for specific Output then the PowerUp state is ignored on this Output. The output stays off after power up without Ethernet connection or until the time is synchronized from NTP server. The Scheduler is waiting for the valid time from NTP and this needs Ethernet/Internet connection. It is to respect schedule if state change occurred during the power outage and prevents against for example short power on "peek".

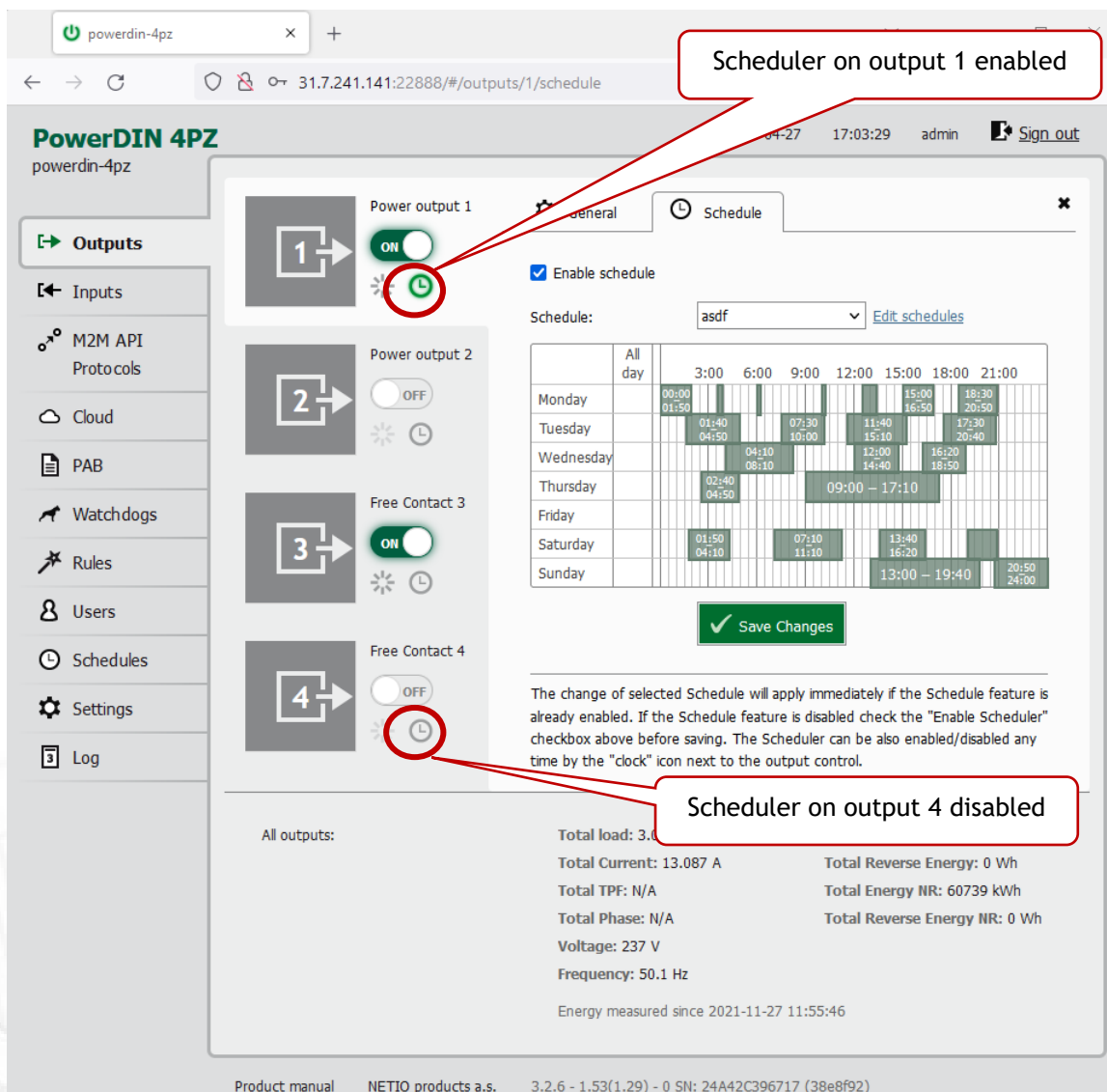



Scheduler on output 1 enabled

Scheduler on output 4 disabled

PowerDIN 4PZ
powerdin-4pz

Power output 1
ON

Power output 2
OFF

Free Contact 3
ON

Free Contact 4
OFF

Enable schedule

Schedule: asdf [Edit schedules](#)

	All day	3:00	6:00	9:00	12:00	15:00	18:00	21:00
Monday	00:00 01:50					15:00 16:50	18:30 20:50	
Tuesday	01:40 04:50		07:30 10:00		11:40 15:10		17:30 20:40	
Wednesday		04:10 08:10			12:00 14:40		16:20 18:50	
Thursday	02:40 04:50			09:00 - 17:10				
Friday								
Saturday	01:50 04:10		07:10 11:10			13:40 16:20		20:50 24:00
Sunday						13:00 - 19:40		

Save Changes

The change of selected Schedule will apply immediately if the Schedule feature is already enabled. If the Schedule feature is disabled check the "Enable Scheduler" checkbox above before saving. The Scheduler can be also enabled/disabled any time by the "clock" icon next to the output control.

All outputs: Total load: 3.0
Total Current: 13.087 A
Total TPF: N/A
Total Phase: N/A
Voltage: 237 V
Frequency: 50.1 Hz
Energy measured since 2021-11-27 11:55:46

Total Reverse Energy: 0 Wh
Total Energy NR: 60739 kWh
Total Reverse Energy NR: 0 Wh

Product manual NETIO products a.s. 3.2.6 - 1.53(1.29) - 0 SN: 24A42C396717 (38e8f92)

Figure 21 - Configuring the Schedule

5.2 Inputs

The PowerDIN 4PZ has two inputs providing their status and S0 counter value.

5.2.1 Digital Inputs - Status and S0 Counters

In the left menu, click Inputs. A screen showing the inputs appears.

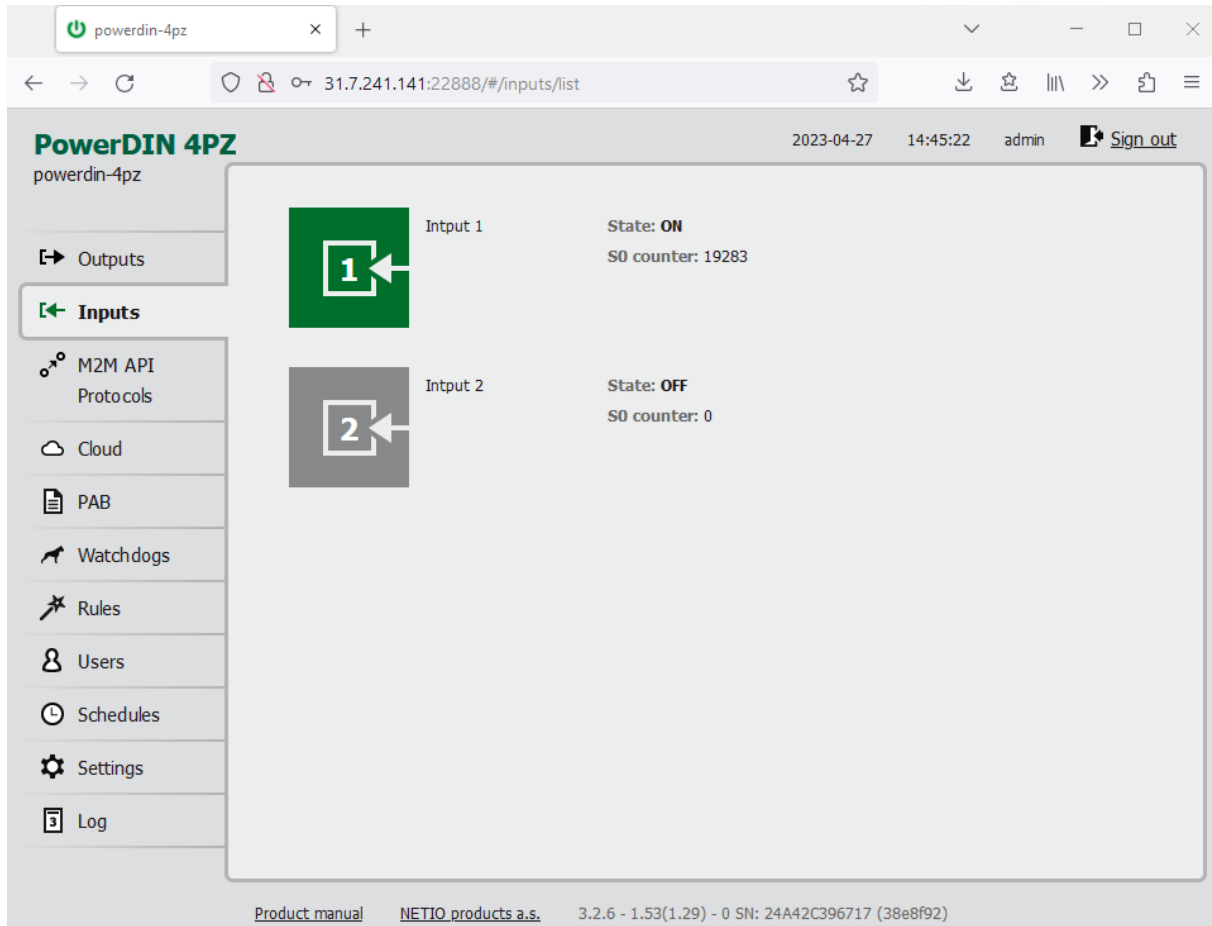

Figure 22 - Viewing the inputs

State

Current state of Digital Input:

- 0 / OFF / “open”
- 1 / ON / “closed”

S0 counter

S0 impulses are counted on each one Digital Input.

It's 32 bit non-resetable counter. Value is stored in the device even during power off.

Each one ON impulse have to be min 30ms long followed by min 30ms OFF state. It means max 16 impulses per second.

5.2.2 Inputs - General

Click the picture of the input to open detailed settings.

The  **General** tab configures basic parameters of the input.

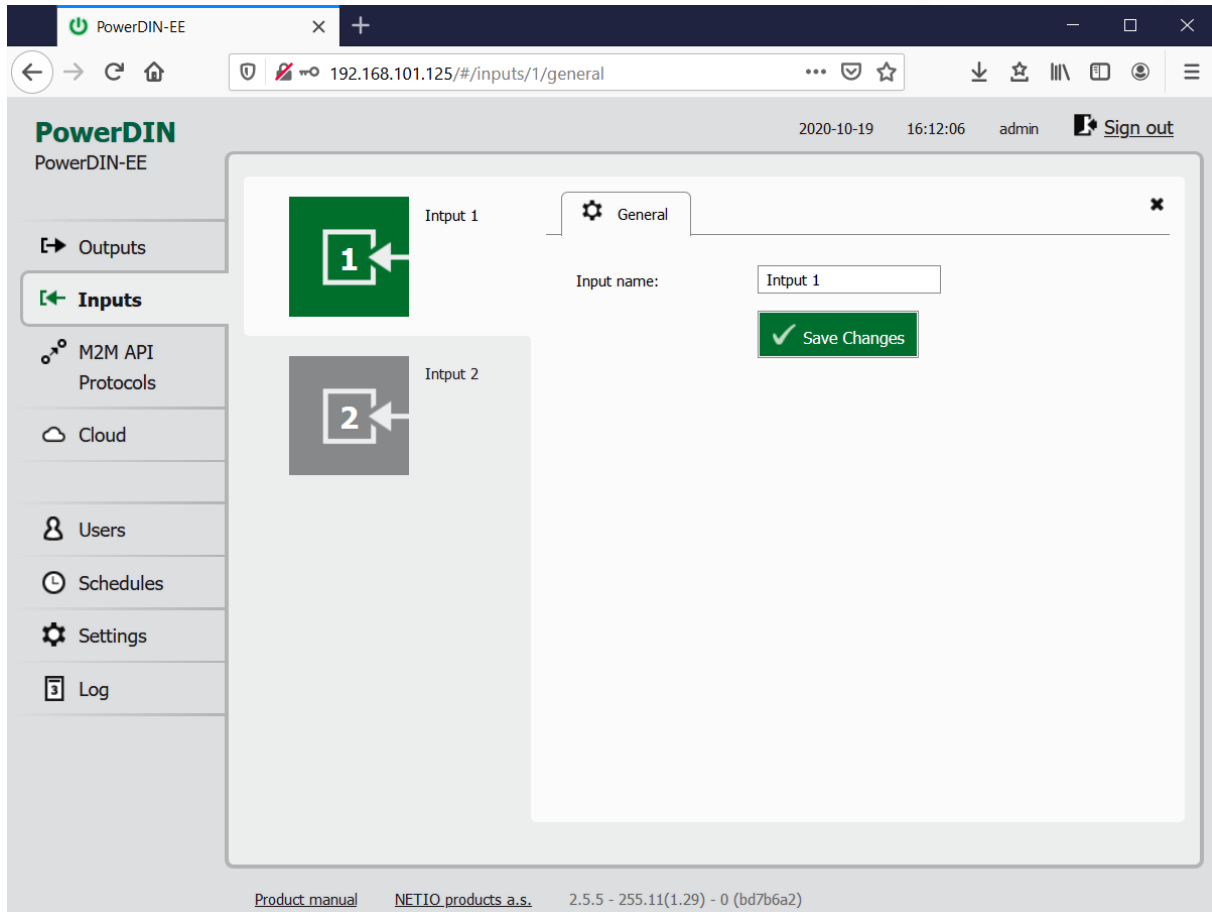



Figure 23 - General input configuration

The Digital **Input name** can be set to identify specific digital input.

Click **Save Changes** to save the settings.

To close the configuration dialog, click the  symbol in the top right corner.

5.3 M2M API Protocols

All M2M protocols use the same values for the **action** parameter to control the output. Allowed values are:

- 0 - turns the output off
- 1 - turns the output on
- 2 - short OFF - turns the output off for a short¹ time (if the output was off, it will be turned on)
- 3 - short ON - turns the output on for a short² time (if the output was on, it will be turned off)
- 4 - toggle - toggles the current output state
- 5 - no operation - leaves the output unchanged
- 6 - ignore - ignores the action attribute and only respects the state attribute - only for XML and JSON

Only one M2M protocol in addition to SNMP can be active at any time!

Following M2M API Protocols cannot run in parallel to NETIO Cloud Connection:

- MQTT-flex
- Netio Push

The notification message appears if you try to enable unsupported combination.

^{1,2} The short-off/short-on duration can be also specified in the command issued over the respective M2M protocol. If unspecified, the "Short ON/OFF delay" value is used.

5.3.1 M2M API Protocol - XML over HTTP

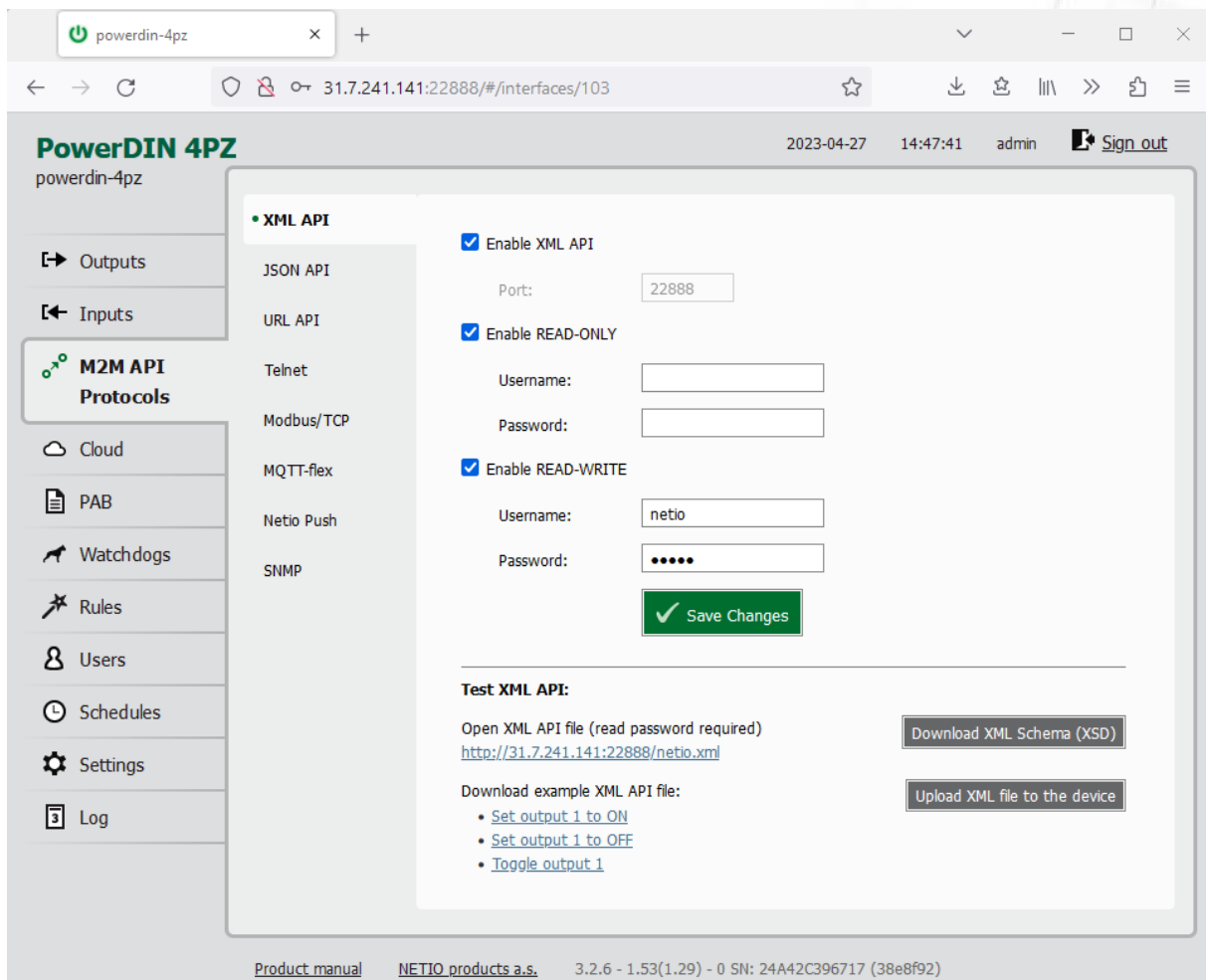

Figure 24 - XML API protocol configuration

Enable XML API	Enables M2M XML API functions in the system kernel.
Port	Read-only value. Indicates the port where the device currently listens for M2M XML API commands. This port is the same for all http based M2M API protocols and web administration and can be changed in Settings / System (chapter System).
Enable READ-ONLY	Enables Read-Only access via M2M XML API for monitoring. You may also fill in the username and password for this mode.
Enable READ-WRITE	Enables Read/Write access for monitoring (reading values) and writing (output control). You may also fill in the username and password for this mode.
Username	Username for the respective access mode (Read-Only/ReadWrite). Note - this is unrelated to the username for accessing the NETIO 4x web administration interface. When left empty, the protocol will not require any authentication.
Password	Password for the corresponding username (Read-Only/ReadWrite).

Save Changes

Saves the changes.

When the XML API is enabled, other M2M protocols are disabled except SNMP. After clicking **Save changes**, the notification message about the deactivation of the other protocol appears.

For an example of reading the output state using XML API, click the “**Test XML API - Open XML API file (read password required)**” link.

After entering the username and password, you will receive an xml file with the NETIO device current state.

URL for downloading/uploading the netio.xml file: <http://<NETIO Device IP>/netio.xml>
e.g. <http://192.168.101.125/netio.xml>

Example of the netio.xml file

```
<?xml version="1.0" encoding="utf-8"?>
<set:Root xmlns:set="http://www.netio-
products.com/XMLSchema/NETIO.xsd">
  <Agent>
    <Model>4PZ</Model>
    <DeviceName>powerdin-4pz</DeviceName>
    <OemID>400</OemID>
    <VendorID>0</VendorID>
    <Version>3.2.6</Version>
    <XmlVer>2.4</XmlVer>
    <SerialNumber>24A42C396717</SerialNumber>
    <MAC>24:A4:2C:39:67:17</MAC>
    <Uptime>220946</Uptime>
    <Time>2023-04-27T14:48:05+01:00</Time>
    <NumOutputs>4</NumOutputs>
    <NumInputs>2</NumInputs>
  </Agent>
  <GlobalMeasure>
    <OverallPowerFactor>999.00</OverallPowerFactor>
    <TotalPowerFactor>999.00</TotalPowerFactor>
    <Voltage>237.06</Voltage>
    <OverallPhase>999.00</OverallPhase>
    <TotalPhase>999.00</TotalPhase>
    <Frequency>50.02</Frequency>
    <TotalLoad>3074</TotalLoad>
    <TotalCurrent>13078</TotalCurrent>
    <TotalEnergy>60730880</TotalEnergy>
    <TotalReverseEnergy>0</TotalReverseEnergy>
    <TotalEnergyNR>60732809</TotalEnergyNR>
    <TotalReverseEnergyNR>0</TotalReverseEnergyNR>
    <EnergyStart>2021-11-27T11:55:46+01:00</EnergyStart>
  </GlobalMeasure>
  <Outputs>
    <Output>
      <ID>1</ID>
      <Name>Power output 1</Name>
      <State>1</State>
```



```

<Action>6</Action>
<Delay>2020</Delay>
<PowerFactor>0.99</PowerFactor>
<Phase>0.02</Phase>
<Load>3072</Load>
<Current>13020</Current>
<Energy>15468757</Energy>
<ReverseEnergy>0</ReverseEnergy>
<EnergyNR>16322100</EnergyNR>
<ReverseEnergyNR>0</ReverseEnergyNR>
</Output>
<Output>
<ID>2</ID>
<Name>Power output 2</Name>
<State>0</State>
<Action>6</Action>
<Delay>2020</Delay>
<PowerFactor>0.00</PowerFactor>
<Phase>271.27</Phase>
<Load>0</Load>
<Current>0</Current>
<Energy>41631666</Energy>
<ReverseEnergy>0</ReverseEnergy>
<EnergyNR>44410709</EnergyNR>
<ReverseEnergyNR>0</ReverseEnergyNR>
</Output>
<Output>
<ID>3</ID>
<Name>Free Contact 3</Name>
<State>1</State>
<Action>6</Action>
<Delay>2020</Delay>
</Output>
<Output>
<ID>4</ID>
<Name>Free Contact 4</Name>
<State>0</State>
<Action>6</Action>
<Delay>2020</Delay>
</Output>
</Outputs>
<Inputs>
<Input>
<ID>1</ID>
<Name>Intput 1</Name>
<State>1</State>
<S0Counter>19283</S0Counter>
</Input>
<Input>
<ID>2</ID>
<Name>Intput 2</Name>
<State>0</State>
<S0Counter>0</S0Counter>
</Input>
</Inputs>
<PAB>
<PABItem><Type>RANGE</Type>

```

```
<Name>CR03_PAB</Name>
<Enabled>>false</Enabled>
<In>>false</In>
</PABItem>
</PAB>
<Watchdogs><WdtItem><Name>default_pinger</Name>
<Enabled>>false</Enabled>
<Fail>>false</Fail>
<LastStatus>>false</LastStatus>
<Timestamp>0</Timestamp>
</WdtItem>
</Watchdogs>
<Rules><Rule><Name>Rule1</Name>
<Enabled>>false</Enabled>
<Result>>false</Result>
</Rule>
<Rule><Name>Rule2</Name>
<Enabled>>false</Enabled>
<Result>>false</Result>
</Rule>
<Rule><Name>Rule3</Name>
<Enabled>>false</Enabled>
<Result>>false</Result>
</Rule>
<Rule><Name>cycling</Name>
<Enabled>>false</Enabled>
<Result>>true</Result>
</Rule>
</Rules>
</set:Root>
```

The following example XML files for controlling the device can be downloaded directly from the web administration:

- Set output 1 to ON
- Set output 1 to OFF
- Toggle output 1

Click **Download XML Schema (XSD)** to download the .xsd schema file.

The **Upload XML file to the device** button opens the following dialog for testing:

HTTP(s) file upload

Host:

Port: Method: **HTTP POST**

Username: Password:

Request #1 (e.g. set-output1-to-1.xml)
 No file selected

Request #2 (e.g. set-output1-to-0.xml)
 No file selected

Request #3 (e.g. toggle-output1.xml)
 No file selected

Response

Figure 25 - Upload XML file dialog

x

Host - URL of the .xml file.

Port - port number used by the XML API protocol.

Username and Password - Username and password configured for the XML API protocol in the READ-WRITE section.

Request #1,2,3 – select .xml file(s) with commands to perform.

Send file - send the selected file(s).

Response - response to the submitted command.

Close - closes the dialog window.

For the specifications of the M2M XML API protocol, visit the **Support > Download** section of our website and see the following document:

[XML - description of NETIO M2M API interface - PDF](#)

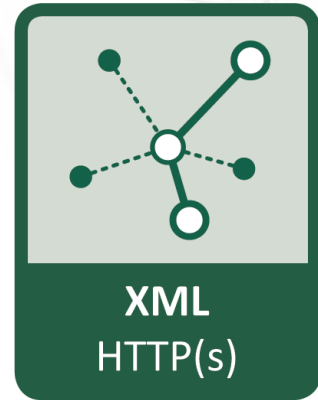

For more information and a practical demonstration of using the XML protocol with NETIO smart sockets, see the following Application Note:

[AN20 XML HTTP\(s\) protocol to control NETIO smart power sockets 110/230V](#)

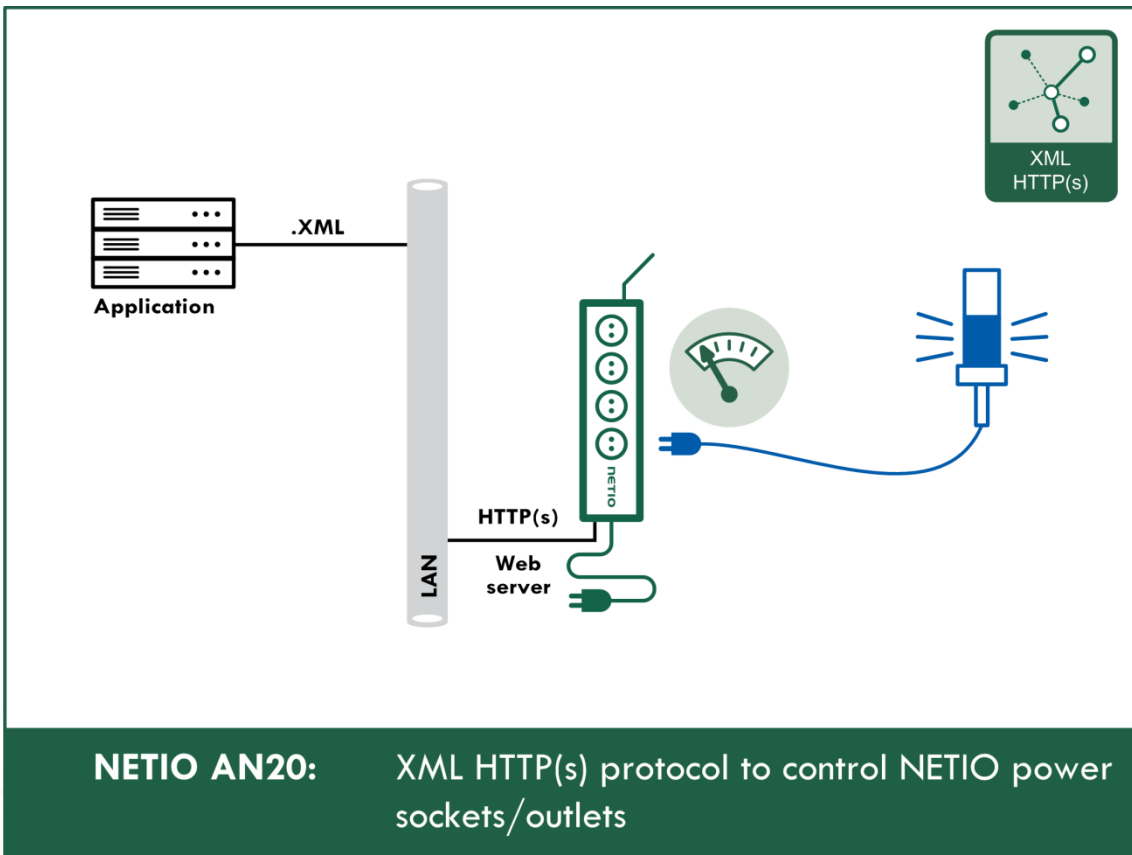

5.3.2 M2M API Protocol - JSON over HTTP

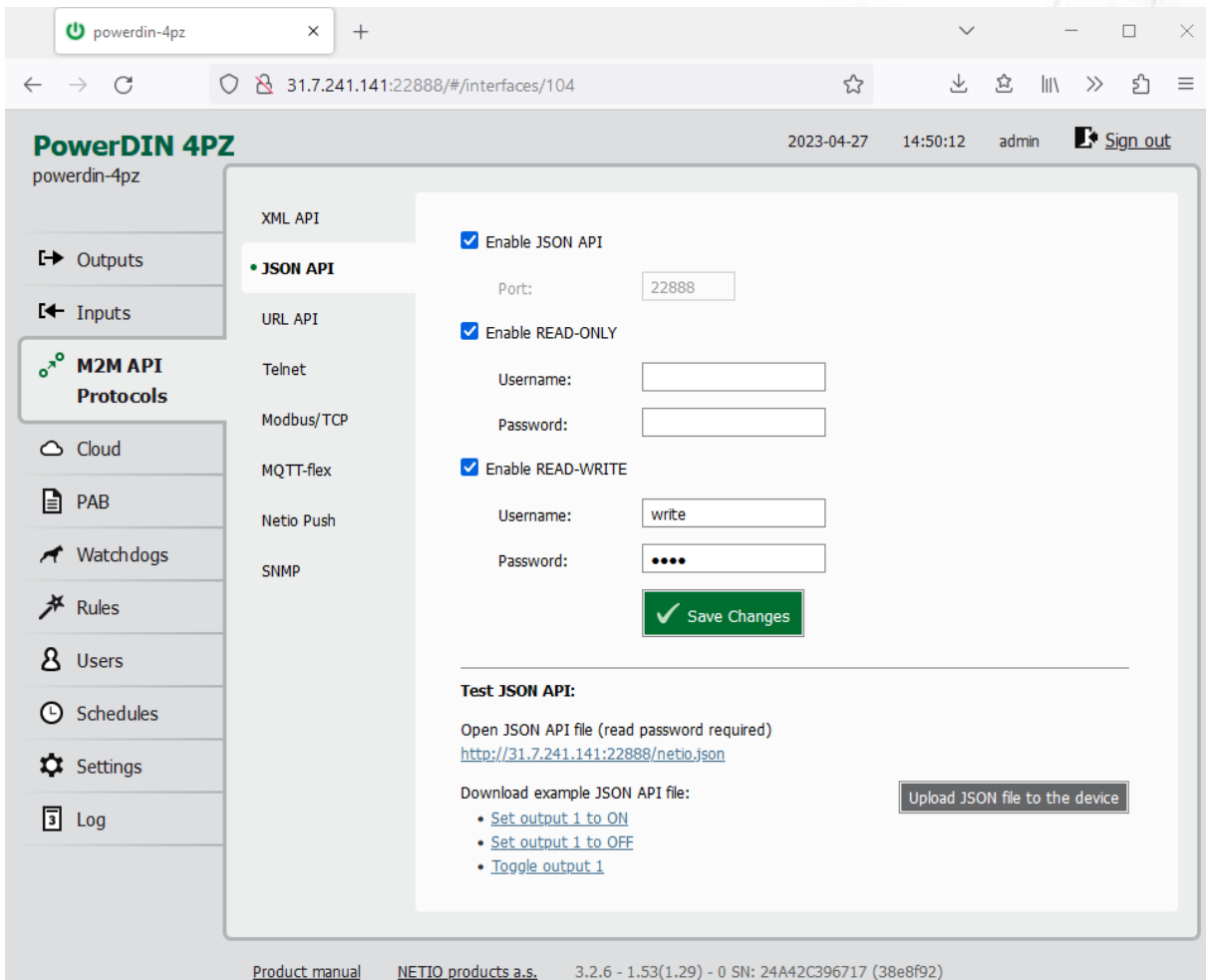

Figure 26 - JSON API protocol configuration

Enable JSON API	Enables M2M JSON API functions in the system kernel.
Port	Read-only value. Indicates the port where the device currently listens for M2M JSON API commands. This port is the same for all http based M2M API protocols and web administration and can be changed in Settings / System (chapter System).
Enable READ-ONLY	Enables Read-Only access via M2M JSON API for monitoring. You may also fill in the username and password for this mode.
Enable READ-WRITE	Enables Read/Write access for monitoring and output control. You may also fill in the username and password for this mode.
Username	Username for the respective access mode (Read-Only/ReadWrite). Note - this is unrelated to the username for accessing the NETIO device web administration. When left empty, the protocol will not require any authentication.
Password	Password for the corresponding username (Read-Only/ReadWrite).
Save Changes	Saves the changes.

When the JSON API protocol is enabled, other M2M protocols are disabled except SNMP. After clicking **Save changes**, the notification message about the deactivation of the other protocol appears.

For an example of reading the output state using JSON API, click the “**Test JSON API: Open JSON API file (read password required)**” link.

After entering the username and password, you will receive a json file with the NETIO device current state.

URL for downloading/uploading the netio.json file: **http://<NETIO Device IP>/netio.json**
e.g. **http://192.168.101.125/netio.json**

Example of the netio.json file

```
{
  "Agent": {"Model": "4PZ", "DeviceName": "powerdin-4pz", "MAC": "24:A4:2C:39:67:17", "SerialNumber": "24A42C396717", "JSONVer": "2.4", "Time": "2023-04-27T14:51:11+01:00", "Uptime": 221131, "Version": "3.2.6", "OemID": 400, "VendorID": 0, "NumOutputs": 4, "NumInputs": 2},
  "GlobalMeasure": {"Voltage": 237.98, "TotalCurrent": 13128, "OverallPowerFactor": 999.00, "TotalPowerFactor": 999.00, "OverallPhase": 999, "TotalPhase": 999, "Frequency": 50.05, "TotalEnergy": 60731040, "TotalReverseEnergy": 0, "TotalEnergyNR": 60732969, "TotalReverseEnergyNR": 0, "TotalLoad": 3095, "EnergyStart": "2021-11-27T11:55:46+01:00"},
  "Outputs": [
    {"ID": 1, "Name": "Power output 1", "State": 1, "Action": 6, "Delay": 2020, "Current": 13057, "PowerFactor": 0.99, "Phase": 359.87, "Energy": 15468916, "ReverseEnergy": 0, "EnergyNR": 16322259, "ReverseEnergyNR": 0, "Load": 3088},
    {"ID": 2, "Name": "Power output 2", "State": 0, "Action": 6, "Delay": 2020, "Current": 0, "PowerFactor": 0.00, "Phase": 271.31, "Energy": 41631666, "ReverseEnergy": 0, "EnergyNR": 44410709, "ReverseEnergyNR": 0, "Load": 0},
    {"ID": 3, "Name": "Free Contact 3", "State": 1, "Action": 6, "Delay": 2020},
    {"ID": 4, "Name": "Free Contact 4", "State": 0, "Action": 6, "Delay": 2020}
  ],
  "Inputs": [
    {"ID": 1, "Name": "Intput 1", "State": 1, "S0Counter": 19283},
    {"ID": 2, "Name": "Intput 2", "State": 0, "S0Counter": 0}
  ]
}
```

```
],  
"PAB": [  
  {"Type": "RANGE", "Name": "CR03_PAB", "Enabled": false, "In": false}  
],  
"Watchdogs": [  
  {"Name": "default_pinger", "Enabled": false, "Fail": false, "LastStatus": false, "Timestamp": 0}  
],  
"Rules": [  
  {"Name": "Rule1", "Enabled": false, "Result": false},  
  {"Name": "Rule2", "Enabled": false, "Result": false},  
  {"Name": "Rule3", "Enabled": false, "Result": false},  
  {"Name": "cycling", "Enabled": false, "Result": true}  
] }
```

The following example json files for controlling the device can be downloaded directly from the web administration:

- Set output 1 to ON
- Set output 1 to OFF
- Toggle output 1

The **Upload JSON file to the device** button opens the following dialog for testing:

✕

HTTP(s) file upload

Host:

Port: Method: **HTTP POST**

Username: Password:

Request #1 (e.g. *set-output1-to-1.json*)

No file selected

Request #2 (e.g. *set-output1-to-0.json*)

No file selected

Request #3 (e.g. *toggle-output1.json*)

No file selected

Response

Host - URL of the .json file.

Port - port number used by the JSON protocol.

Username and Password - username and password configured for the JSON protocol in the READ-WRITE section.

Request #1,2,3 – select .json file(s) with commands to perform.

Send file - send the selected file(s).

Response - response to the submitted command.

Close - closes the dialog window.

Figure 27 - Upload JSON file dialog

For more information about the M2M JSON API, visit the **Support > Download** section of our website and see the following document:

[JSON - description of NETIO M2M API interface - PDF](#)

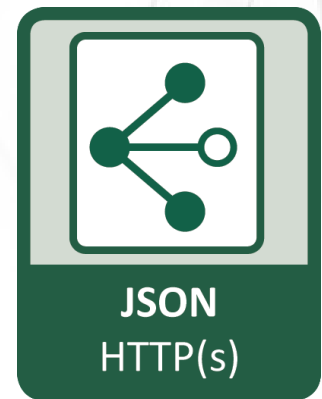

For more information and a practical demonstration of using the JSON protocol with NETIO smart sockets, see the following Application Note:

[AN21 JSON HTTP\(S\) protocol to control NETIO 110/230V power sockets \(3x REST API\)](#)

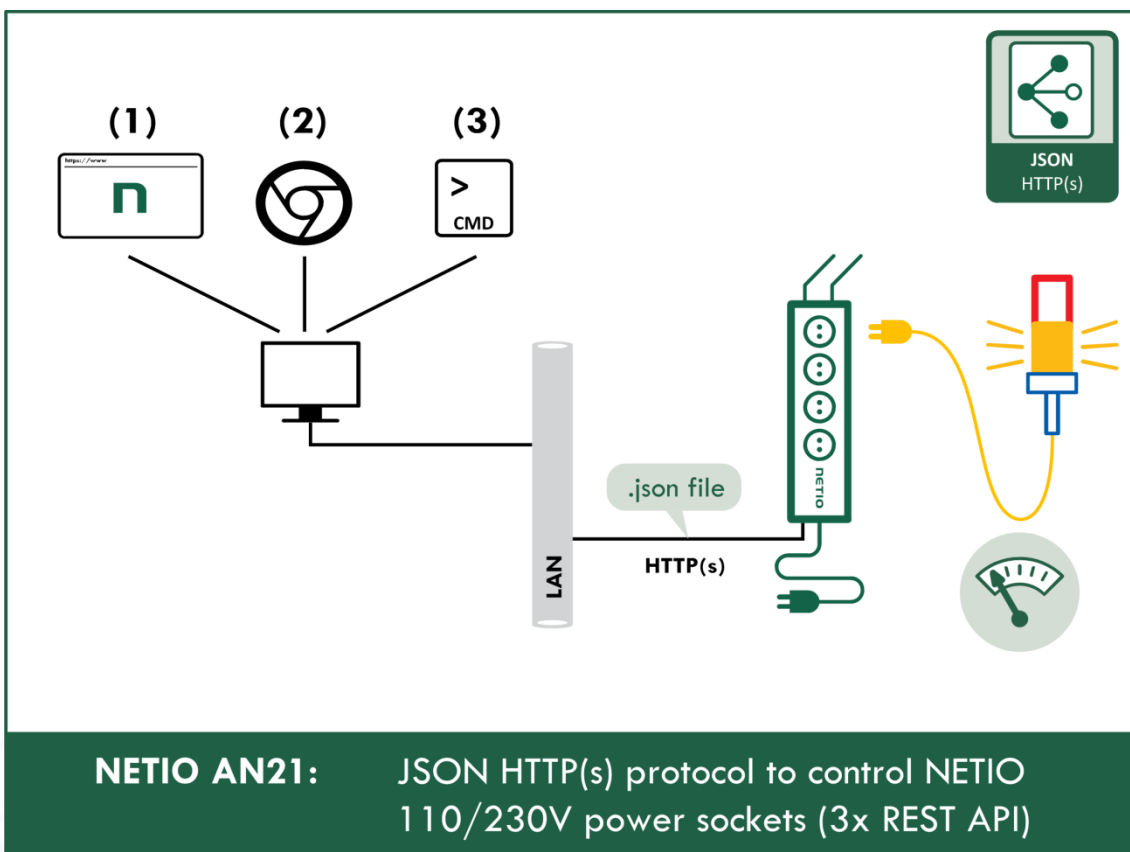

5.3.3 M2M API Protocol - URL API (http get)

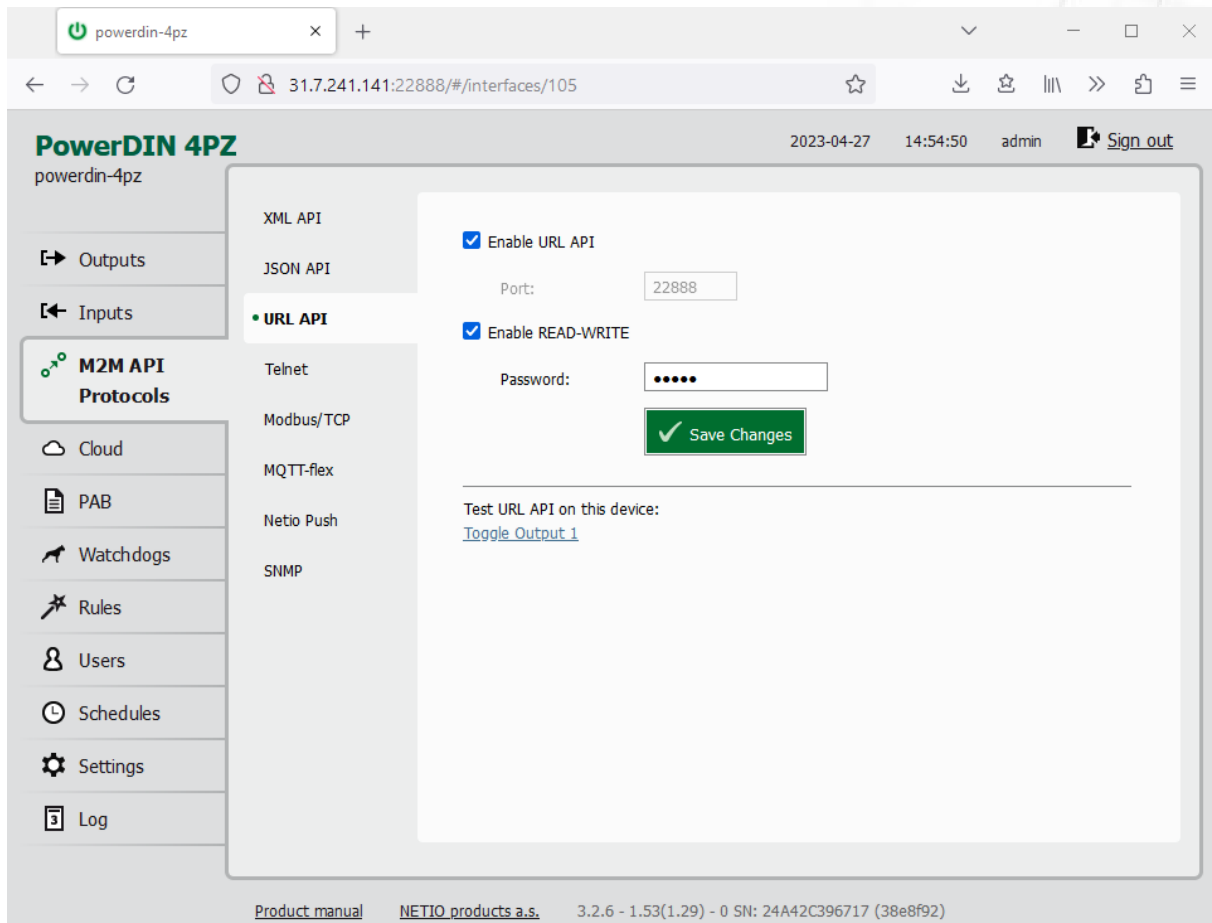

Figure 28 -URL API protocol configuration

Enable URL API	Enables M2M URL API functions in the system kernel.
Port	Read-only value. Indicates the port where the device currently listens for M2M URL API commands. This port is the same for all http based M2M API protocols and web administration and can be changed in Settings / System (chapter System).
Enable READ-WRITE	Enables READ-WRITE access.
Password	Password to authenticate HTTP GET communication (pass attribute in the request).
Save Changes	Saves the changes.

When the URL API is enabled, other M2M protocols are disabled except SNMP. After clicking **Save changes**, the notification message about the deactivation of the other protocol appears.

For an example of toggling output no. 1 using the M2M URL API, click the link under **Test URL API**.

This opens a new browser tab and invokes the following HTTP GET request:

`http://<NETIO Device IP>/netio.cgi?pass=<Password>&output1=4`

e.g. `http://192.168.101.125/netio.cgi?pass=netio&output1=4`

For more information about the M2M URL API, visit the **Support > Download** section of our website and see the following document:

[URL API - description of NETIO M2M API interface - PDF](#)



For more information and a practical demonstration of using the URL-API protocol with NETIO smart sockets, see the following Application Note:

[AN19 URL API \(http GET\) protocol to control NETIO 4x power sockets/outlets 110 / 230V](#)

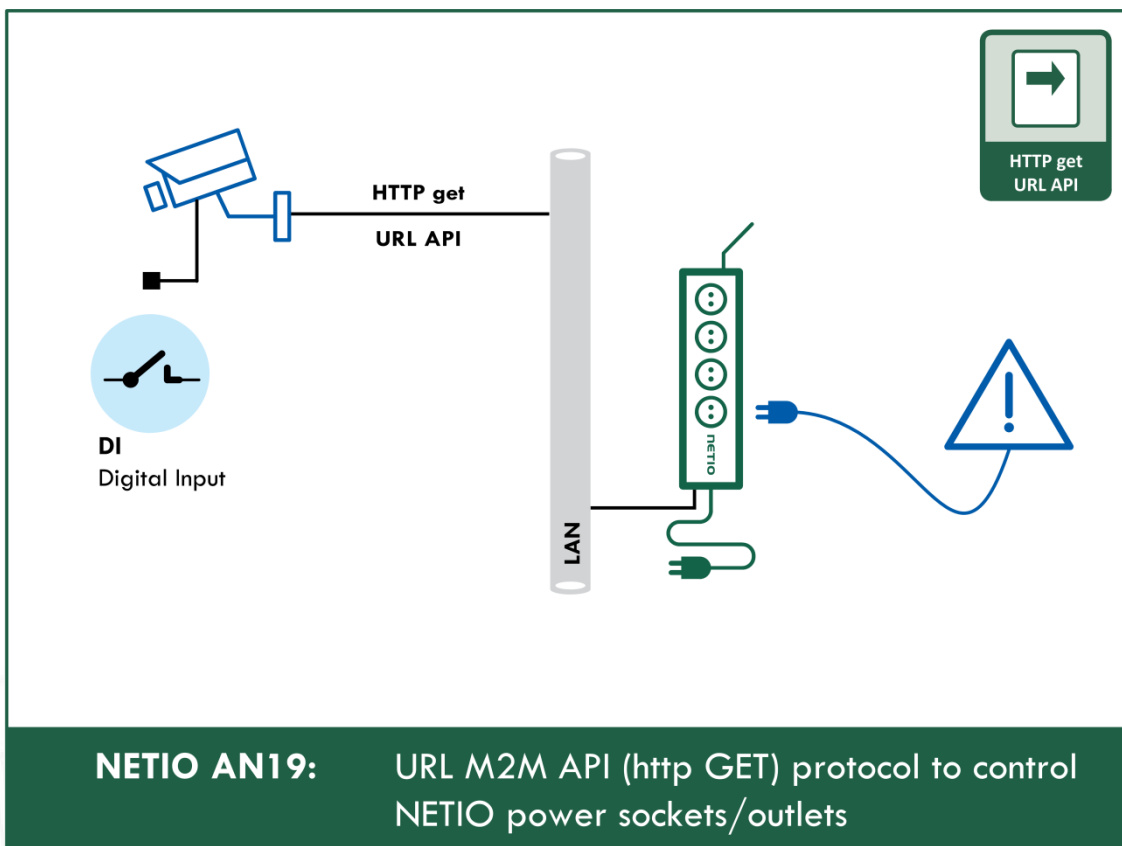

5.3.4 M2M API Protocol - Telnet

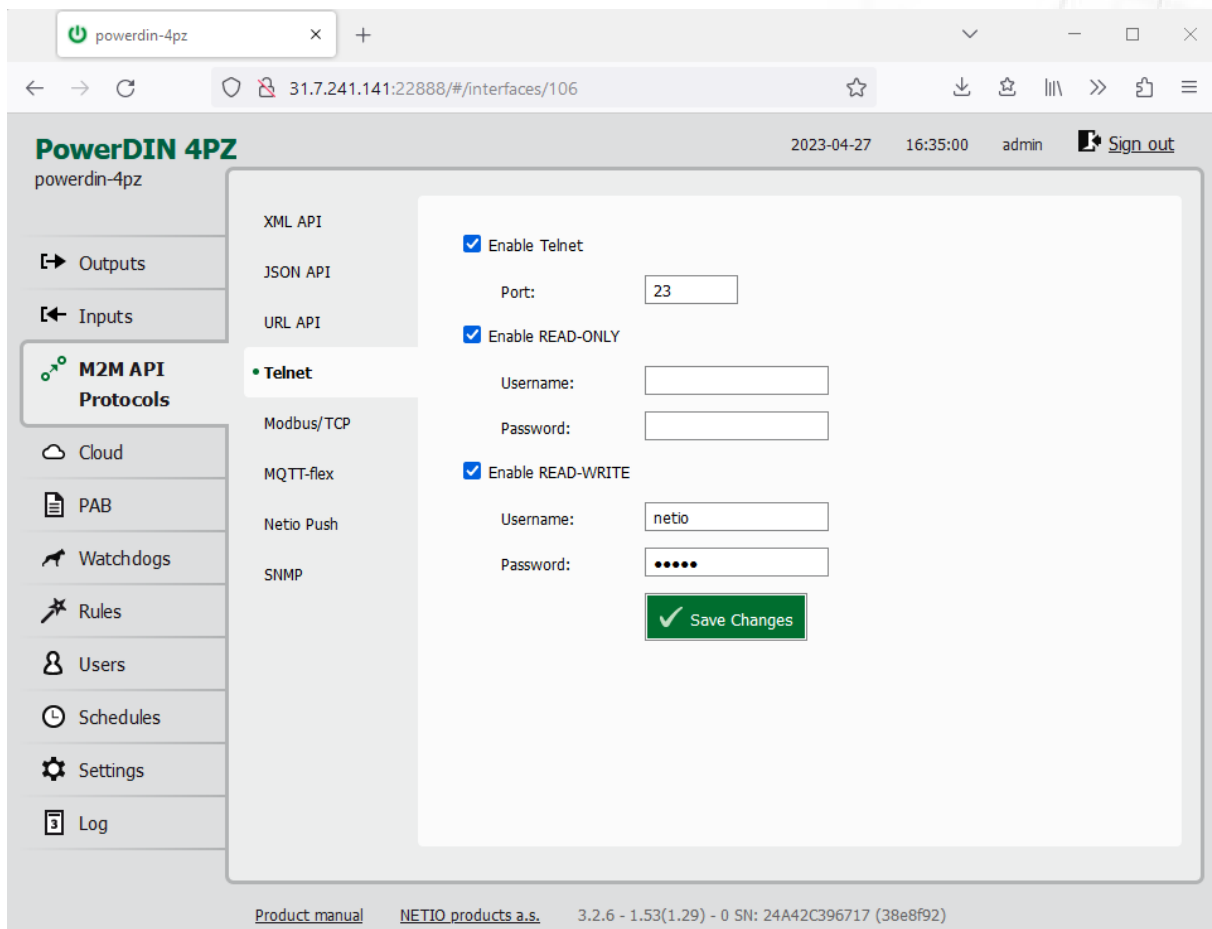

Figure 29 - Telnet protocol configuration

Enable Telnet	Enables M2M Telnet functions in the system kernel.
Port	Specific port for Telnet only, range 1 - 65535. Be aware, that you should enter value, which is not already occupied by another M2M protocol or web interface.
Enable READ-ONLY	Enables Read-Only access via M2M Telnet API for monitoring. You may also fill in the username and password for this mode.
Enable READ-WRITE	Enables Read/Write access for monitoring and output control. You may also fill in the username and password for this mode.
Username	Username for the respective access mode (Read-Only/ReadWrite). Note - this is unrelated to the username for accessing the NETIO device web administration. When left empty, the protocol will not require any authentication.
Password	Password for the corresponding username (Read-Only/ReadWrite).
Save Changes	Saves the changes.

Telnet protocol does not contain energy measurement data and counters. This protocol is recommended to Outputs control only.

When the Telnet is enabled, other M2M protocols are disabled except SNMP. After clicking **Save changes**, the notification message about the deactivation of the other protocol appears.

Start Telnet connection to a NETIO device IP address and its Telnet port

When the connection is established, the NETIO device returns the following response and is ready to receive commands.

Telnet welcome message

```
100 HELLO C9C410A0 - KSHELL V2.2
```

Note: The Telnet connection is automatically terminated after 60 seconds of inactivity. It is possible to use the *noop* command to keep the connection alive for the next 60 seconds.

Command set

Command	Description
login <username> <password>	Log in a user. Replace <username> and <password> by the equivalent attributes defined in the Telnet protocol configuration (Figure 28) <password> Example - log in with username <i>netio</i> and password <i>netio</i> : login netio netio
quit	Log out and terminate Telnet connection.
noop	Keep the Telnet connection alive for the next 60 seconds. No-operation
port list [xxxx]	Control/monitor of all outputs based on the parameters xxxx (described below) for each output. All parameters x must have valid value otherwise the command will not be accepted (e.g. port list 10x1 is invalid). If no parameters are provided, then it returns states of all outputs. Outputs are numbered from the left to right (1-2-3-4). Control all outputs (1 and 4: ON, 2 and 3: OFF):

	<pre>port list 1001 250 OK</pre> <p>Returns state of output:</p> <pre>port list 250 1001</pre> <p>(outputs 1 and 4 are ON, 2 and 3 OFF)</p>
port <output> <action>	<p>Control the output. <output> is replaced by the output number (1) <action> is replaced by a parameter described below If no <action> is provided, the state of the output is returned.</p>
input list	<p>Returns state of input.</p> <pre>input list 250 10</pre> <p>(input is ON)</p>

Each command must be followed by CR and LF characters (hexadecimal 0D and 0A). Typically, you can use Enter in the terminal.

Parameters <action> for *port* command

Parameter	Action
0	Turn OFF
1	Turn OFF
2	Short OFF delay (restart)
3	Short ON delay
4	Toggle (invert the state)
5	No change

Command examples

Switch power output 1 to ON:

```
port 1 1
```

Switch power output 1 to OFF:

```
port 1 0
```

Toggle power output 1:

```
port 1 4
```

Status codes

Status code	Description
110 BYE	Connection terminated by client after command quit
130 CONNECTION TIMEOUT	No command submitted for longer than 60 seconds. The Telnet connection is terminated.
250 OK	The command is accepted.
500 INVALID VALUE	The command parameter is not valid.
501 INVALID PARAMETR	The command parameter is not valid.
502 UNKNOWN COMMAND	The command is not valid.
505 FORBIDDEN	An attempt to make an action with not sufficient permission (i.e.: control output with read only user, try to monitor output state with non-logged user, where ReadOnly user is password protected etc.)
510 OUT OF RANGE	Specified value is not valid (i.e. trying to control port 4 on device, which has only 1 socket)

For more information about the Telnet protocol, visit the **Support > Download** section of our website and see the following document:

[Telnet - description of NETIO M2M API interface - PDF](#)



For more information and a practical demonstration of using the Modbus/TCP protocol with NETIO smart sockets, see the following Application Note:

[AN10 Telnet control of electrical power sockets \(M2M API - KSHELL\)](#)

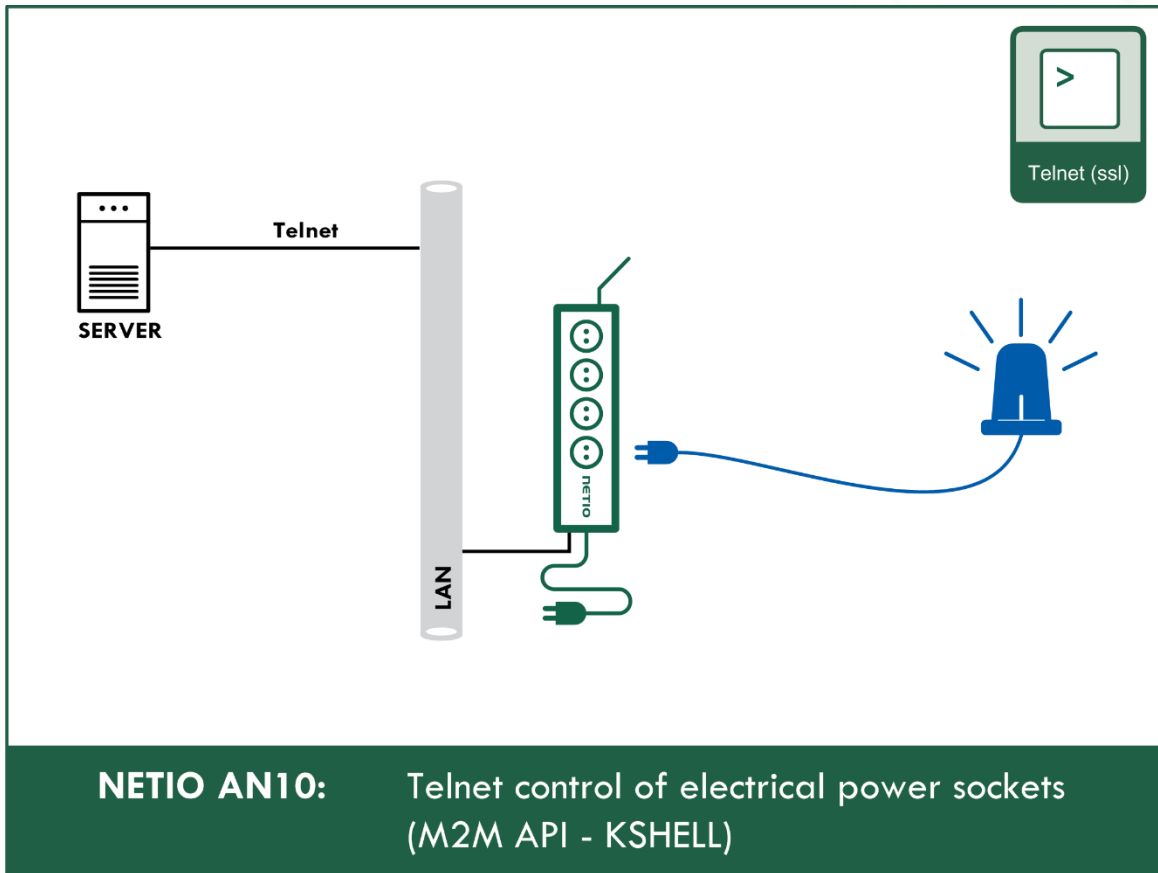

5.3.5 M2M API Protocol - Modbus/TCP

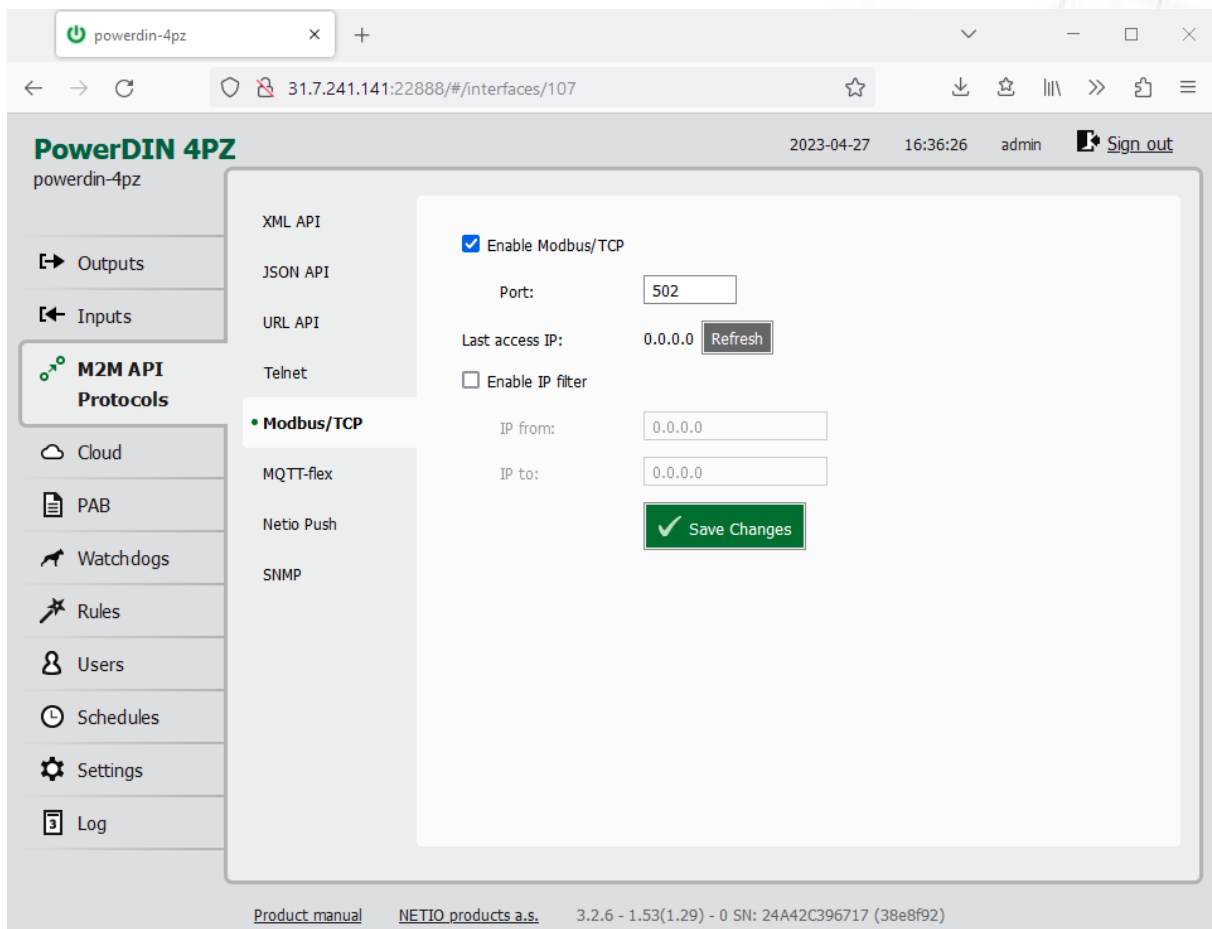

Figure 30 - Modbus/TCP protocol configuration

Enable Modbus/TCP	Enables M2M Modbus/TCP functions in the system kernel.
Port	Specific port for Modbus/TCP only, range 1 - 65535. The device do NOT alerts you if you specify a port number that is already occupied.
Last access IP	Read-only value indicating the IP address from which the last Modbus/TCP command was received. The “Refresh” button updates this value.
Enable IP filter	To improve security, the IP filter can be used to specify a range of IP addresses from which Modbus/TCP commands are accepted. Commands from addresses outside of this range will be ignored.
Save Changes	Saves the changes.

When the Modbus/TCP is enabled, other M2M protocols are disabled except SNMP. After clicking **Save changes**, the notification message about the deactivation of the other protocol appears.

Protocol properties

- Modbus/TCP Unit ID is ignored. Can be anything 0 to 247
- **Wire Address = Register Address - 1**
 - The Wire Address starts from 0
 - The Register Address starts from 1
 - Register Address is called “PLC based addressing” in some applications (Modbus Poll for example)
 - Some utilities using the Wire Address (QModMaster used in AN27 for example)

Modbus/TCP function and registers overview (Register addresses used and Wire address in brackets on the first line)

Function	Register	Value	Description
0x01	102 (101)	0/1	Read 1st output state (101 when Wire address used)
0x01	103	0/1	Read 2nd output state
0x01	104	0/1	Read 3rd output state
0x01	105	0/1	Read 4th output state
0x02	802	0/1	Read 1st input state
0x02	803	0/1	Read 2st input state
0x03	1	uInt16	Number of digital inputs
0x03	2	uInt16	Number of outputs (Power Sockets/Outlets)
0x03	3	uInt16	Number of metered Power Sockets/Outlets
0x03	102	uInt16	1st output state
0x03	103	uInt16	2nd output state
0x03	104	uInt16	3rd output state
0x03	105	uInt16	4th output state
0x03	202	uInt16	"Short" delay of 1st output [1/10sec]
0x03	203	uInt16	"Short" delay of 2nd output [1/10sec]
0x03	204	uInt16	"Short" delay of 3rd output [1/10sec]
0x03	205	uInt16	"Short" delay of 4th output [1/10sec]
0x04	1	uInt16	Power grid frequency [1/100 Hz]
0x04	2	uInt16	Voltage [1/10V] - RMS
0x04	3	uInt16	OverAll TruePowerFactor [1/1000] (value 9999=not measured)
0x04	4	uInt16	All outputs current [mA] (double)
0x04	5	uInt16	All outputs power [W] (double)
0x04	6	Int16	All outputs Phase shift [1/10°] (value 9999=not measured)
0x04	101	uInt16	All outputs current [mA]
0x04	102	uInt16	1st output current [mA]
0x04	103	uInt16	2nd output current [mA]
0x04	201	uInt16	All outputs power [W]
0x04	202	uInt16	1st output power [W]
0x04	203	uInt16	2d output power [W]

0x04	301	uInt16	All outputs energy counter - 2 upper bytes [Wh]
0x04	302	uInt16	All outputs energy counter - 2 lower bytes [Wh]
0x04	303	uInt16	1st output energy counter - 2 upper bytes [Wh]
0x04	304	uInt16	1st output energy counter - 2 lower bytes [Wh]
0x04	305	uInt16	2nd output energy counter - 2 upper bytes [Wh]
0x04	306	uInt16	2nd output energy counter - 2 lower bytes [Wh]
0x04	401	uInt16	All outputs TPF [1/1000]
0x04	402	uInt16	1st output TPF [1/1000]
0x04	403	uInt16	2nd output TPF [1/1000] (value 9999=not measured)
0x04	501	Int16	All outputs Phase shift [1/10°]
0x04	502	Int16	1st output Phase shift [1/10°]
0x04	503	Int16	2nd output Phase shift [1/10°] (value 9999=not measured)
0x04	601	uInt16	All out. reverseEnergy counter - 2up.bytes [Wh]
0x04	602	uInt16	All out. reverseEnergy counter - 2lo.bytes [Wh]
0x04	603	uInt16	1st out. reverseEnergy counter - 2up.bytes [Wh]
0x04	604	uInt16	1st out. reverseEnergy counter - 2lo.bytes [Wh]
0x04	605	uInt16	2nd out. reverseEnergy counter - 2up.bytes [Wh]
0x04	606	uInt16	2nd out. reverseEnergy counter - 2lo.bytes [Wh]
0x04	803	uInt16	1st digital input S0 counter - 2 upper bytes
0x04	804	uInt16	1st digital input S0 counter - 2 lower bytes
0x04	805	uInt16	2nd digital input S0 counter - 2 upper bytes
0x04	806	uInt16	2nd digital input S0 counter - 2 lower bytes
0x04	1001	uInt16	All outputs energy NR counter - 2 upper bytes [Wh]
0x04	1002	uInt16	All outputs energy NR counter - 2 lower bytes [Wh]
0x04	1003	uInt16	1st output energy NR counter - 2 upper bytes [Wh]
0x04	1004	uInt16	1st output energy NR counter - 2 lower bytes [Wh]
0x04	1005	uInt16	2nd output energy NR counter - 2 upper bytes [Wh]
0x04	1006	uInt16	2nd output energy NR counter - 2 lower bytes [Wh]
0x04	1101	uInt16	All out. reverseEnergy NR counter - 2up.bytes [Wh]
0x04	1102	uInt16	All out. reverseEnergy NR counter - 2lo.bytes [Wh]
0x04	1103	uInt16	1st out. reverseEnergy NR counter - 2up.bytes [Wh]
0x04	1104	uInt16	1st out. reverseEnergy NR counter - 2lo.bytes [Wh]
0x04	1105	uInt16	2nd out. reverseEnergy NR counter - 2up.bytes [Wh]
0x04	1106	uInt16	2nd out. reverseEnergy NR counter - 2lo.bytes [Wh]
0x05	102	0/1	Turn On/Off 1st output (Write)
0x05	103	0/1	Turn On/Off 2nd output
0x05	104	0/1	Turn On/Off 3rd output
0x05	105	0/1	Turn On/Off 4th output
0x06	102	uInt16	Set action to 1st output
0x06	103	uInt16	Set action to 2nd output
0x06	104	uInt16	Set action to 3rd output
0x06	105	uInt16	Set action to 4th output

0x06	202	uInt16	Set "Short" delay of 1st output [1/10sec]
0x06	203	uInt16	Set "Short" delay of 2nd output [1/10sec]
0x06	204	uInt16	Set "Short" delay of 3rd output [1/10sec]
0x06	205	uInt16	Set "Short" delay of 4th output [1/10sec]

For more information about the M2M Modbus/TCP protocol, visit the **Support > Download** section of our website and see the following document:

[Modbus / TCP - description of NETIO M2M API interface - PDF](#)

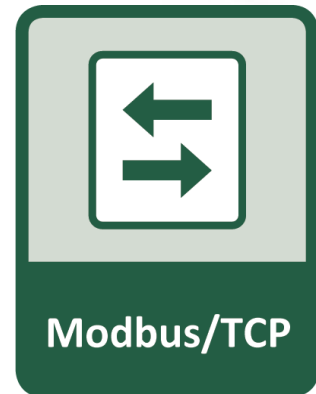

For more information and a practical demonstration of using the Modbus/TCP protocol with NETIO smart sockets, see the following Application Note:

[AN27: Modbus/TCP with NETIO 4x - Control and measure LAN power sockets](#)

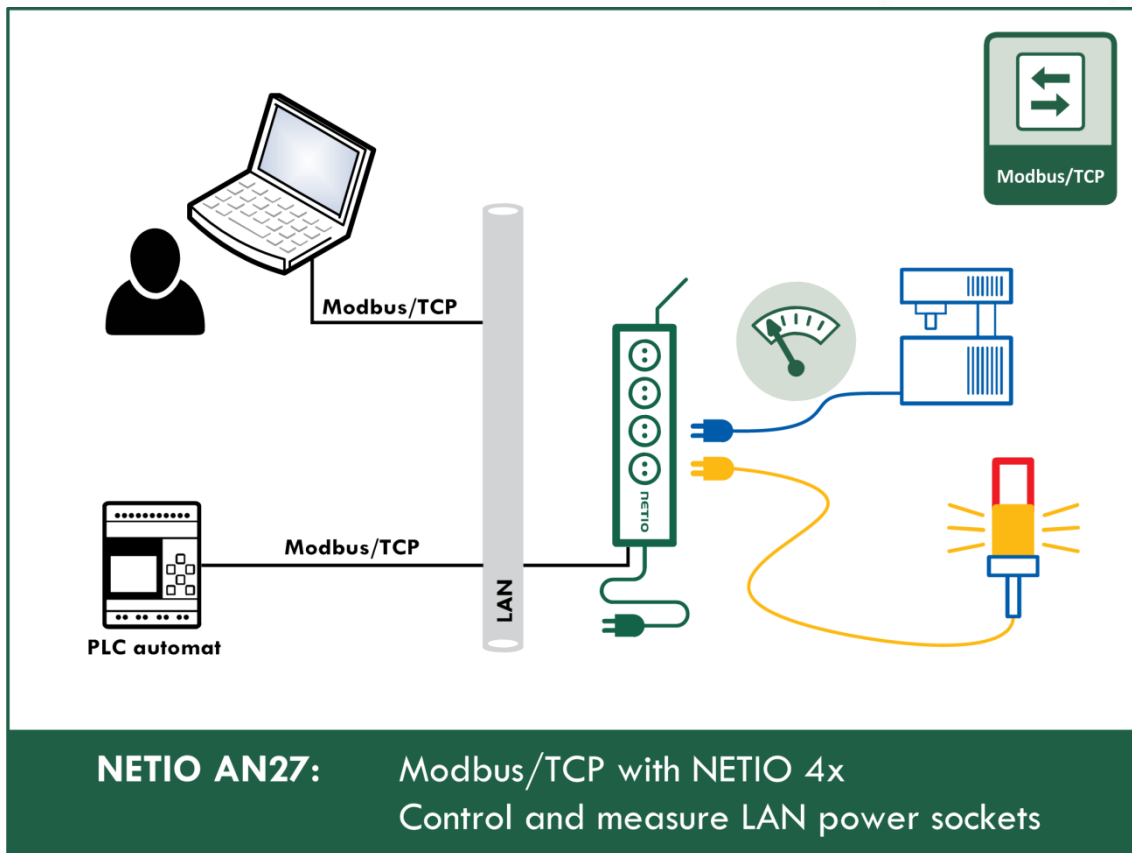

5.3.6 M2M API Protocol - MQTT-flex

The screenshot shows the PowerDIN 4PZ web interface. The browser address bar shows the URL `31.7.241.141:22888/#/interfaces/108`. The page title is "PowerDIN 4PZ" and the user is logged in as "admin". The left sidebar contains navigation options: Outputs, Inputs, M2M API Protocols (selected), Cloud, PAB, Watchdogs, Rules, Users, Schedules, Settings, and Log. The main content area shows the MQTT-flex configuration page. The "Enable MQTT-flex" checkbox is checked. Below it is a text area for the MQTT-flex config (max 6000 characters) containing the following JSON configuration:

```

1 {
2   "broker": {
3     "clientid": "netio${DEVICE_SN}",
4     "keepalive": 30,
5     "password": "",
6     "port": 1883,
7     "protocol": "mqtt",
8     "ssl": false,
9     "type": "generic",
10    "url": "broker.hivemq.com",
11    "username": ""
12  },
13  "publish": [
14    {
15      "events": [
16        {
17          "source": "OUTPUTS/1/STATE",
18          "type": "change"
19        },
20        {
21          "source": "OUTPUTS/2/STATE"

```

At the bottom of the configuration area, there is a green "Save Changes" button with a checkmark icon. Below the button is a link to the "MQTT-flex - Online Configuration Manual".

Figure 31 - MQTT-flex protocol configuration

Enable MQTT-flex

Enables MQTT-flex functions in the system kernel.

MQTT-flex Config:

Text area for entering the MQTT-flex configuration.

Save Changes

Saves the changes.

When the MQTT-flex is enabled, other M2M protocols are disabled except SNMP. After clicking **Save changes**, the notification message about the deactivation of the other protocol appears.

NETIO device uses json to define the MQTT-flex structure (MQTT-flex Config). Both subscribe and publish topics can be defined. Publish topics may include actions that initiate a transmission.

MQTT-flex configuration example:

```
{
  "broker": {
    "clientid": "netio${DEVICE_SN}",
    "keepalive": 30,
    "password": "",
    "port": 1883,
    "protocol": "mqtt",
    "ssl": false,
    "type": "generic",
    "url": "broker.hivemq.com",
    "username": ""
  },
  "publish": [
    {
      "events": [
        {
          "source": "OUTPUTS/1/STATE",
          "type": "change"
        },
        {
          "source": "OUTPUTS/2/STATE",
          "type": "change"
        },
        {
          "source": "OUTPUTS/3/STATE",
          "type": "change"
        },
        {
          "source": "OUTPUTS/4/STATE",
          "type": "change"
        },
        {
          "delta": 200,
          "source": "OUTPUTS/1/CURRENT",
          "type": "delta"
        },
        {
          "delta": 200,
          "source": "OUTPUTS/2/CURRENT",
          "type": "delta"
        },
        {
          "source": "INPUTS/1/STATE",
          "type": "change"
        },
        {
          "source": "INPUTS/2/STATE",
          "type": "change"
        },
        {
          "delta": 250,
          "source": "INPUTS/1/S0",

```

```

        "type": "delta"
    },
    {
        "delta": 250,
        "source": "INPUTS/2/S0",
        "type": "delta"
    },
    {
        "period": 3600,
        "type": "timer"
    }
],
"payload": "${OUTPUTS_STATUS}",
"qos": 0,
"retain": true,
"topic": "devices/${DEVICE_NAME}/messages/devicebound/"
}
],
"subscribe": [
    {
        "action": "${payload}",
        "qos": 0,
        "target": "REST_JSON",
        "topic": "devices/${DEVICE_NAME}/messages/events/"
    }
]
}

```

For more information about the M2M MQTT-flex API, visit the **Support > Download** section of our website and see the following document:

[MQTT-flex - description of NETIO M2M API interface - PDF](#)

There are wide options for subscribe and publish sections and its possibilities expand over the time.

You will find details and examples at our online resource center:
<https://wiki.netio-products.com/index.php?title=MQTT-flex>

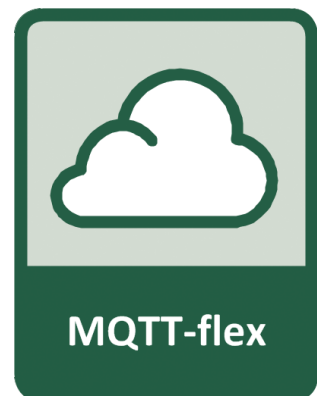

For more information and a practical demonstration of using the MQTT protocol with NETIO smart sockets, see the following Application Note:

[AN40 Getting started with PowerCable MQTT-flex via HiveMQ MQTT broker to mobile App](#)

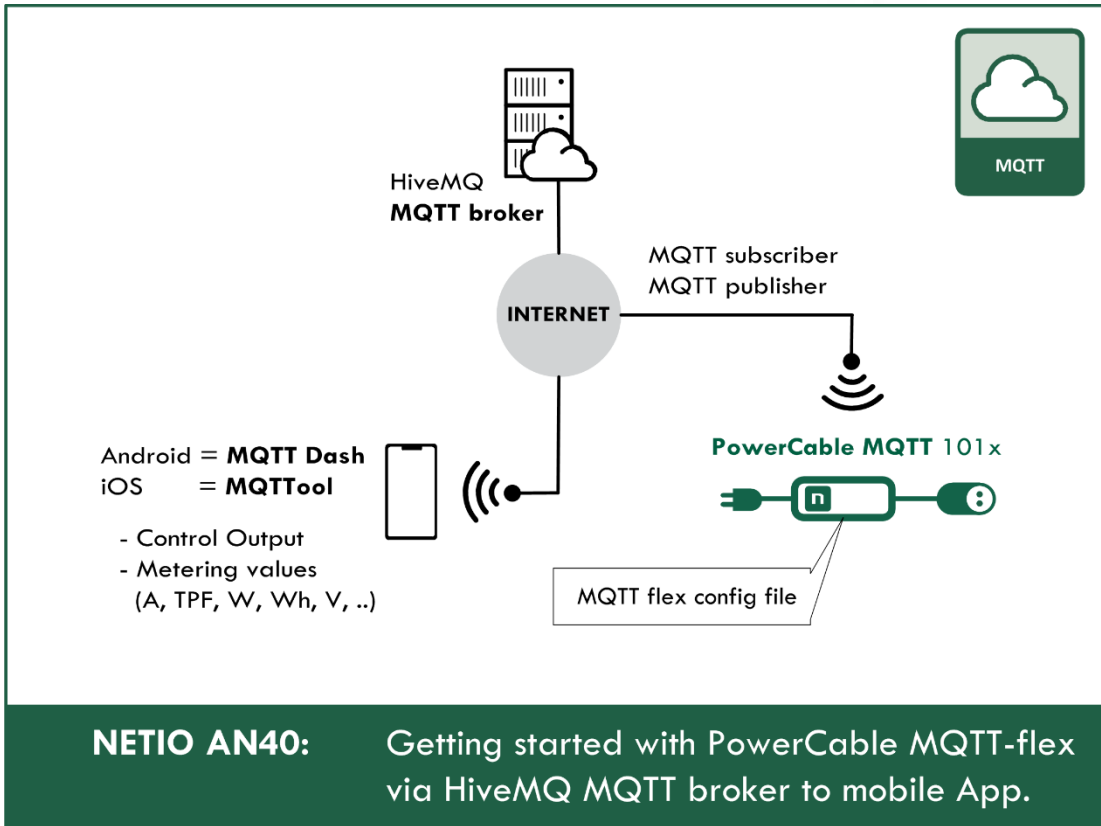

5.3.7 M2M API Protocol - Netio Push

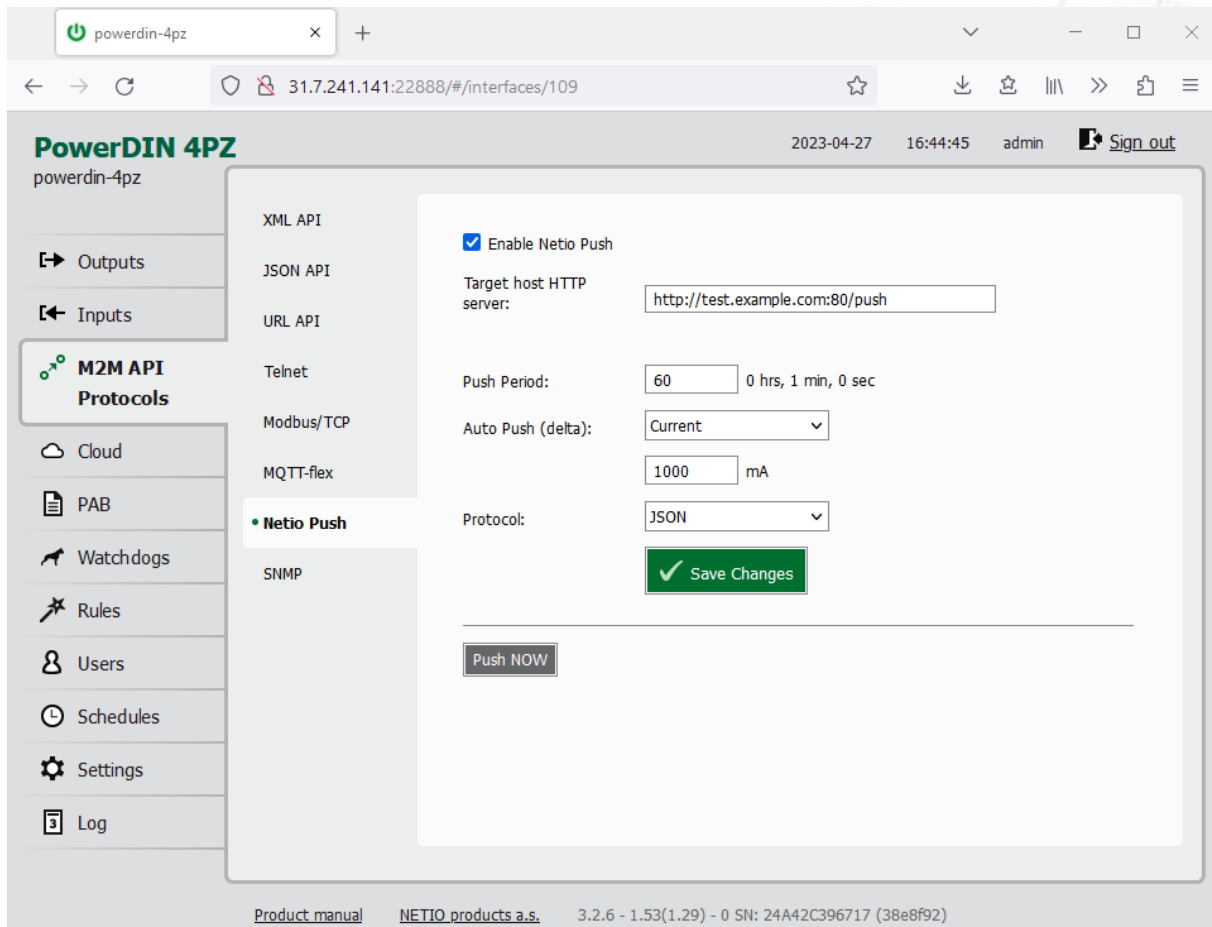

Figure 32 - Netio Push protocol configuration

Enable Netio Push	Enables Netio Push functions in the system kernel.
Target host HTTP server:	<p>Defines the parameters of the target:</p> <ul style="list-style-type: none"> - http / https to specify the protocol - Target URL - Port - Username and Password <p>Example: https://username:password@test.example.com:80/push</p>
Push Period	Period for the automatic sending of data (Push), in seconds.
Auto Push (delta)	<p>Data will be immediately sent (Push) if a measured value exceeds this limit.</p> <p>Parameter - at this time, only Current</p> <p>Value - limit value for the selected parameter</p>
Protocol	<p>Selects the payload format.</p> <ul style="list-style-type: none"> - JSON - XML

Save Changes

Saves the changes.

When the Netio Push is enabled, other M2M protocols are disabled except SNMP. After clicking **Save changes**, the notification message about the deactivation of the other protocol appears.

Data (payload - JSON/XML) are automatically periodically sent to the target address using HTTP(s), depending on the configured push period.

Output control over the NETIO PUSH - JSON

Device is periodically connecting to the Target host http(s) server within push period (default 60seconds). It means the output can be switched only when the TCP/IP connection is established. In default once every 60 seconds.

If the response from Target host is error code 200 (OK) and the payload contains valid NETIO JSON structure with control command then the Output will be set accordingly. This way is possible to control device even if this is in private network behind NAT.

The NETIO JSON structure is described in section [M2M API Protocol - JSON \(REST M2M API\)](#).

For more information about the M2M HTTP(s) Push API, visit the **Support > Download** section of our website and see the following document:

[HTTP\(s\) Push JSON - description of NETIO M2M API interface - PDF](#)

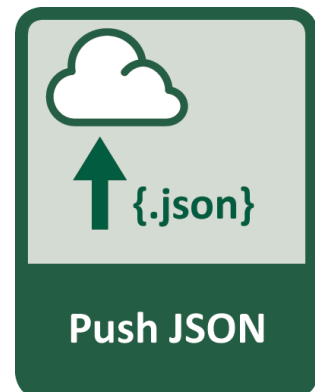

5.3.8 M2M API Protocol - SNMP

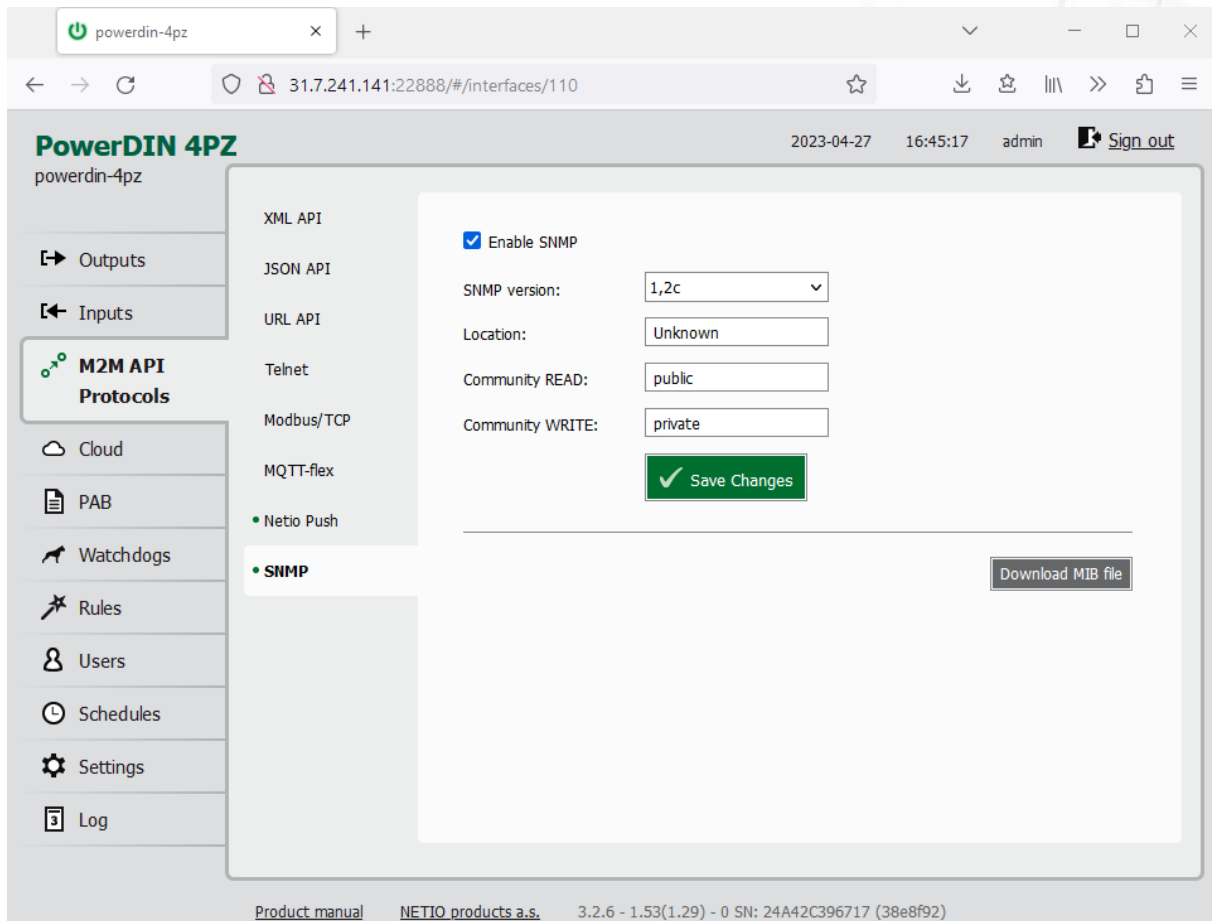

Figure 33 - SNMP API protocol configuration

Enable SNMP

Enables M2M SNMP API functions in the system kernel.
The port is 161.

SNMP version

1,2c - unsecured, unencrypted
3 - secured

Location

Define system location (sysLocation).

Community READ

Also called the “community string” in SNMP. Similar to a username/password combination. Needed for **reading** information from NETIO device over SNMP.

We recommend to use “pure” ASCII characters (that is, to avoid accented and special characters, such as @, & and so on, if possible).

Community WRITE

Also called the “community string” in SNMP. Similar to a username/password combination. Needed for **writing** commands to NETIO device over SNMP.

We recommend to use “pure” ASCII characters (that is, to avoid accented and special characters, such as @, & and so on, if possible).

Save Changes

Saves the changes.

[Download MIB file](#)

Use this button to download MIB.

The MIB can be downloaded from a device web administrator as described above.

Following standard MIBs are also required:

- SNMPv2-SMI
- SNMPv2-TC

Monitoring (read)

x = Output/Input number

Object OID	Type	Value example	Note
netioOutputID.x.0 1.3.6.1.4.1.47952.1.1.1.x.0	INTEGER	1	
netioOutputName.x.0 1.3.6.1.4.1.47952.1.1.1.2.x.0	STRING	output_1	Based on user defined name
netioOutputState.x.0 1.3.6.1.4.1.47952.1.1.1.3.x.0	INTEGER	off(0), on(1)	
netioOutputStateString.x.0 1.3.6.1.4.1.47952.1.1.1.4.x.0	STRING	"off", "on"	
netioOutputLoad.x.0 1.3.6.1.4.1.47952.1.1.1.25.x.0	INTEGER	24	[W]
netioOutputEnergy.x.0 1.3.6.1.4.1.47952.1.1.1.26.x.0	INTEGER	13	[Wh]
netioOutputEnergyStart.x.0 1.3.6.1.4.1.47952.1.1.1.27.x.0	DateAnd Time	2017-6- 23,5:47:3.0,+ 0:0	Initial date and time. UTC based
netioOutputCurrent.x.0 1.3.6.1.4.1.47952.1.1.1.28.x.0	INTEGER	195	[mA]
netioOutputPowerFactor.x.0 1.3.6.1.4.1.47952.1.1.1.29.x.0	INTEGER	534	Current power factor * 1000
netioOutputPhase.x.0 1.3.6.1.4.1.47952.1.1.1.30.x.0	INTEGER	31683	[°] * 100
netioOutputReverseEnergy.x.0 1.3.6.1.4.1.47952.1.1.1.31.x.0	INTEGER	4747	[Wh]
netioOutputEnergyNR.x.0 1.3.6.1.4.1.47952.1.1.1.32.x.0	INTEGER	4093	[Wh]
netioOutputReverseEnergyNR.x.0 1.3.6.1.4.1.47952.1.1.1.33.x.0	INTEGER	6751	[Wh]
netioVoltage.0 1.3.6.1.4.1.47952.1.2.1.0	INTEGER	239100	Voltage in the power grid [mV]
netioFrequency.0 1.3.6.1.4.1.47952.1.2.2.0	INTEGER	49900	Frequency in the power grid [mHz]

netioTotalCurrent.0 1.3.6.1.4.1.47952.1.2.3.0	INTEGER	195	[mA]
netioOverallPowerFactor.0 1.3.6.1.4.1.47952.1.2.4.0	INTEGER	534	Total TPF *1000 <i>Not available in PowerPDU 8QS</i>
netioTotalLoad.0 1.3.6.1.4.1.47952.1.2.5.0	INTEGER	24	Total Load [W]
netioTotalEnergy.0 1.3.6.1.4.1.47952.1.2.6.0	INTEGER	13	Total Energy [Wh]
netioEnergyStart.0 1.3.6.1.4.1.47952.1.2.7.0	DateAnd Time	2017-6-23,5:47:3.0,+0:0	Initial date and time. UTC based
netioTotalPhase.0 1.3.6.1.4.1.47952.1.2.8.0	INTEGER	27581	Total Phase * 100 [°] <i>Not available in PowerPDU 8QS</i>
netioTotalReverseEnergy.0 1.3.6.1.4.1.47952.1.2.9.0	INTEGER	6664	Total Reverse Energy [Wh]
netioTotalEnergyNR.0 1.3.6.1.4.1.47952.1.2.10.0	INTEGER	72987	[Wh]
netioTotalReverseEnergyNR.0 1.3.6.1.4.1.47952.1.2.11.0	INTEGER	8877	[Wh]
netioInputID.x.0 1.3.6.1.4.1.47952.1.3.1.1.x.0	INTEGER	1	
netioInputName.x.0 1.3.6.1.4.1.47952.1.3.1.2.x.0	STRING	Input 1	Based on user defined name
netioInputState.x.0 1.3.6.1.4.1.47952.1.3.1.3.x.0	INTEGER	0	
netioInputStateString.x.0 1.3.6.1.4.1.47952.1.3.1.4.x.0	STRING	off	
netioInputSOCCounter.x.0 1.3.6.1.4.1.47952.1.3.1.5.x.0	INTEGER	5	

Control (write)

x = Output number

Object OID	Type	Value	Action
netioOutputAction.x.0 1.3.6.1.4.1.47952.1.1.1.5.x.0	INTEGER (i)	0 1 2 3 4 5	Turn OFF Turn ON Short OFF delay (restart) Short ON delay Toggle (invert the state) No change

For more information about the M2M SNMP API, visit the **Support > Download** section of our website and see the following document:

[SNMP API - description of NETIO M2M API interface - PDF](#)

Note: There are differences compare to description in PDF:

- PowerDIN 4PZ can be controlled over SNMP v1/2c
- All Objects/OIDs have added “.0” at the end (the tables on this and previous page contain correct/full Objects/OIDs).

Please contact NETIO support in case of questions.

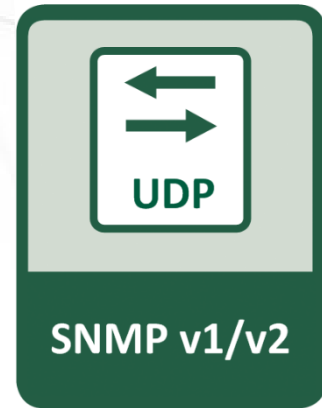

For more information and a practical demonstration of using the SNMP protocol with NETIO smart sockets, see the following Application Note:

[SNMP management of 110/230V power outlets from the command line in Windows and Linux](#)

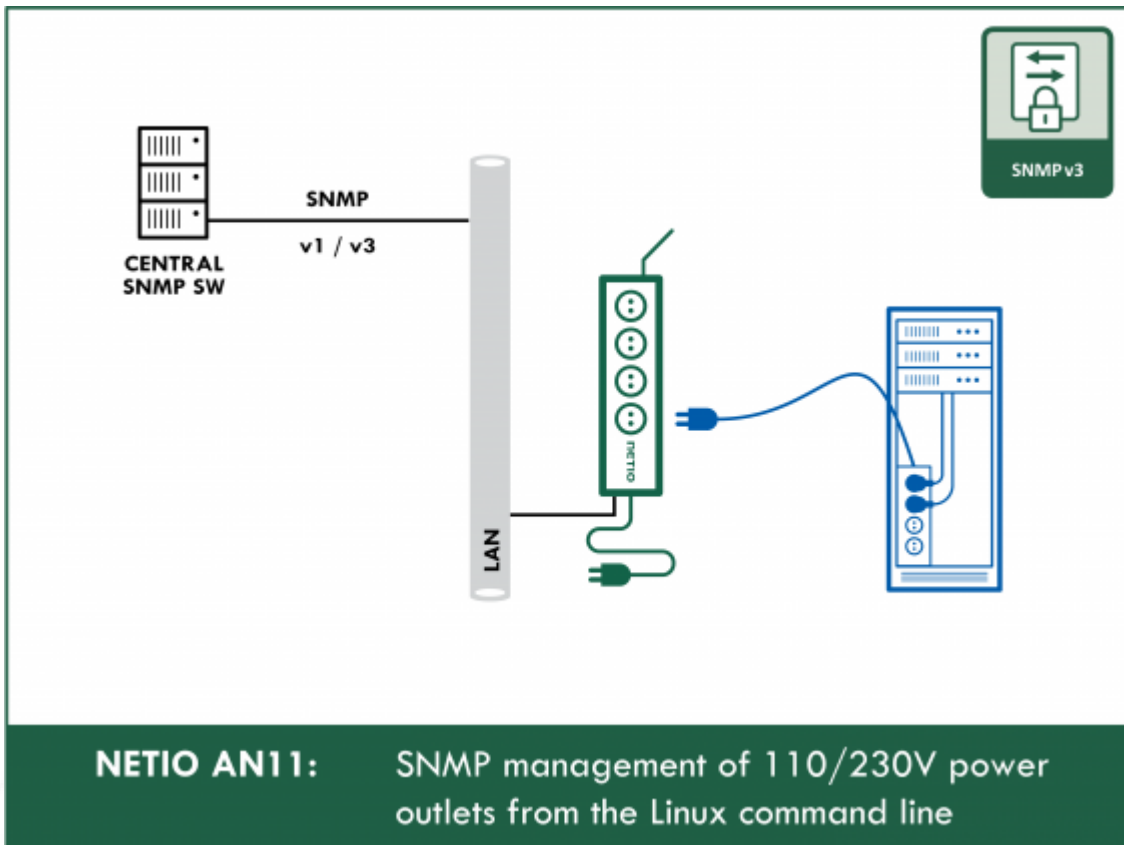

5.4 Cloud

Netio Cloud is a service provided by NETIO Products a.s. and allow easy central remote control and monitoring of the NETIO devices. What can you do in NETIO Cloud?

Output control

- On/Off switch.
- Reset button (Short Off for defined time).
- Show power consumption [kWh] per output (metered device only)

Settings

- Output name can be modified.
- Outputs can be placed to any of groups.
- Short OFF (restart) interval for reset can be set up.

NETIO Cloud is a paid service, but the current customers will gain some free credits with each device added to their NETIO Cloud account.

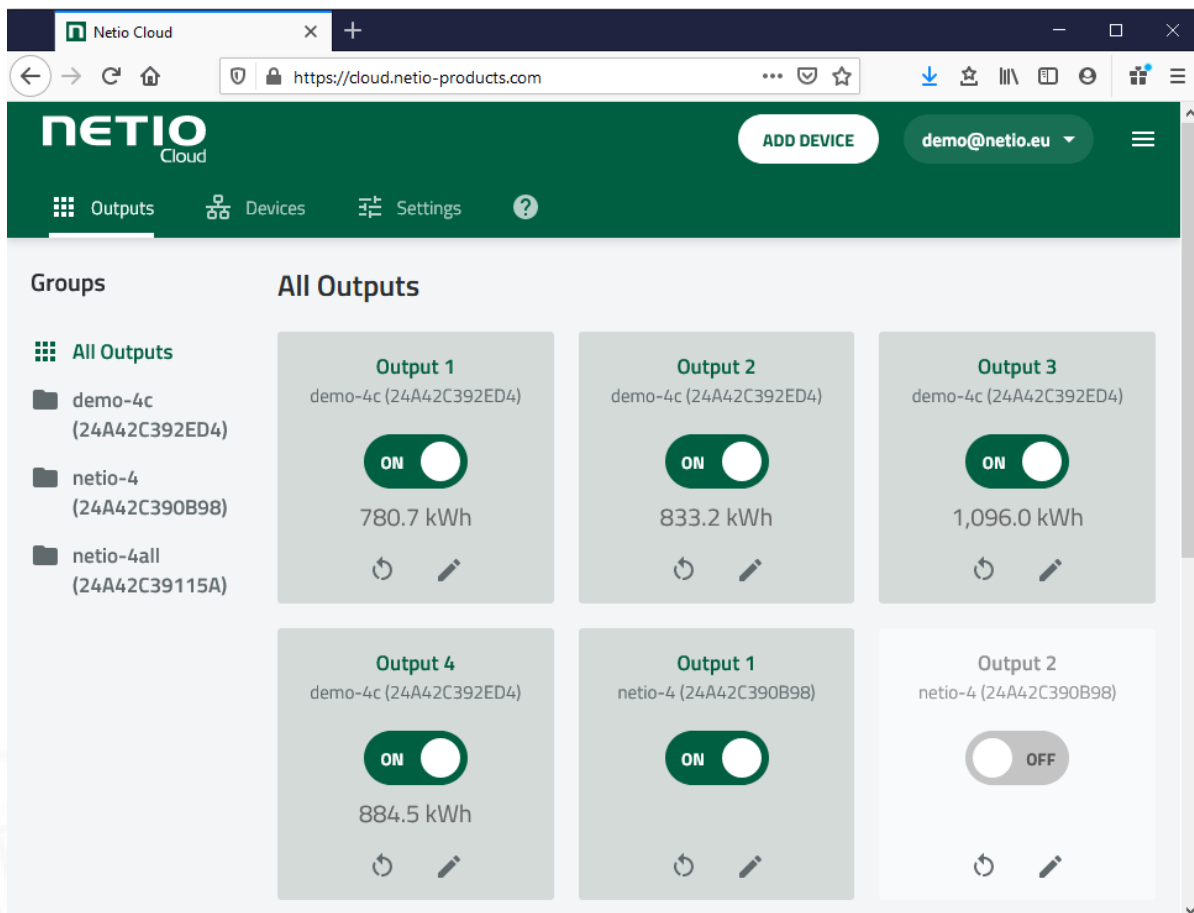

Figure 34 - NETIO Cloud

Connection to NETIO Cloud can be configured on Cloud tab.

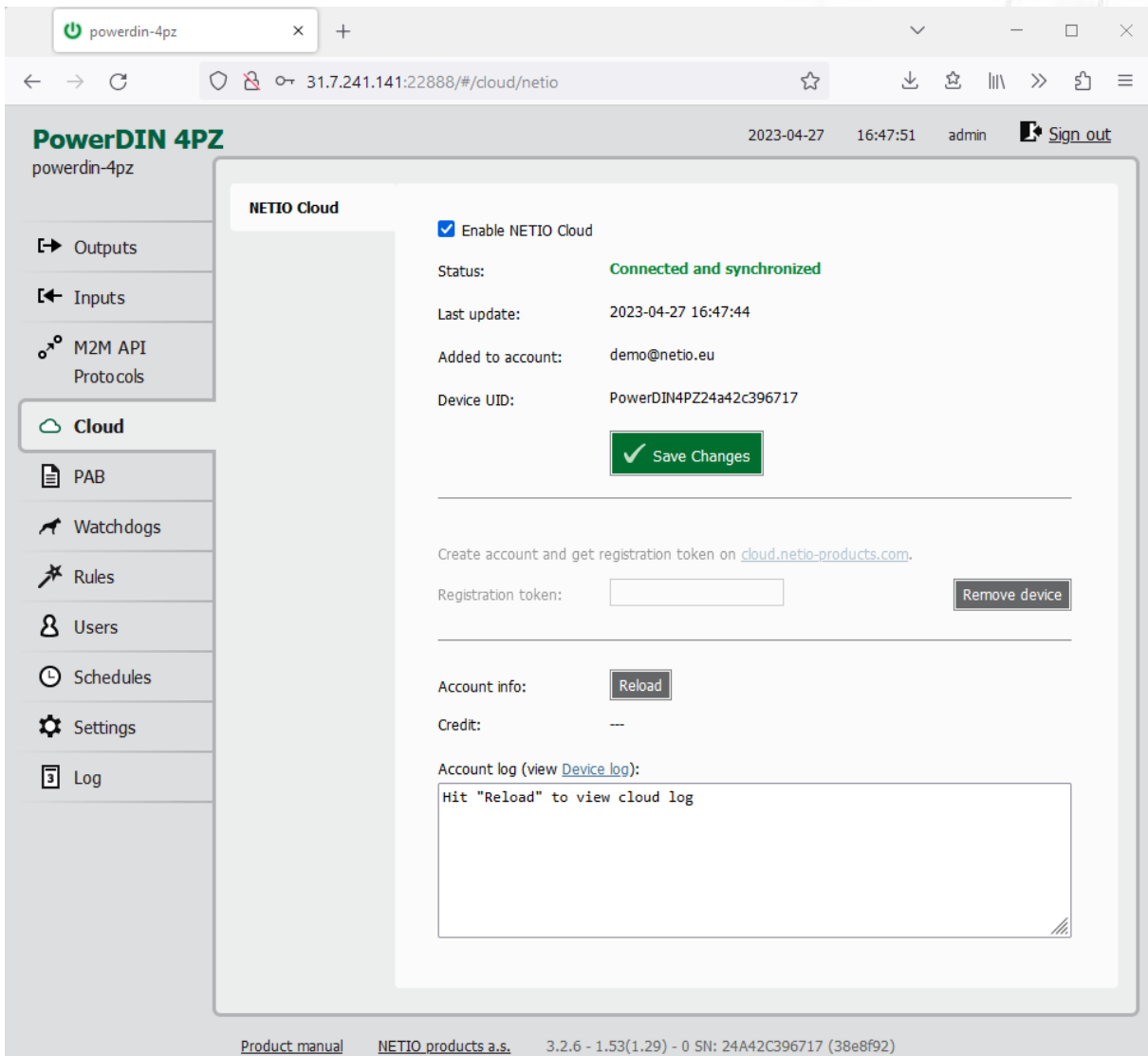

Figure 35 - Cloud configuration

Enable NETIO Cloud	Check to enable NETIO Cloud.
Status	<p>Off: NETIO Cloud disabled</p> <p>Disconnected: Device not connected to Cloud</p> <p>Cloud connect failed...reconnecting: Device it trying to connect to Cloud.</p> <p>Connected: Device connected to NETIO Cloud.</p> <p>Connected and synchronised: Device connected to NETIO Cloud and account information synchronized.</p>
Last update	Date and time of the last update.
Added to account	Account name to what this device is assign.
Device UID	Unique device ID.

Save Changes

Saves the changes.

Registration token

Enter the registration token from NETIO Cloud web - shown when "ADD DEVICE" button used. Then press "Add device" button.

Remove device

If this device is connected to NETIO Cloud use this button to remove/disconnect it from NETIO Cloud.

Account info

Use "Reload" button tu refresh account information.

Credit

Value of the available credit for Cloud account.

Account log

Log of the Cloud account events.

5.5 PAB

The PAB (Power Analysis Block) is **Condition & Rules (C&R)** function available for NETIO devices that periodically evaluates sets of conditions. Based on these conditions, subsequent [Rules](#) can be executed. These conditions can consist of one or more of following variables:

Current [mA], Energy [Wh], Load [W], Power Factor, S0 pulses

Several PAB's can be configured and running simultaneously.

You will find details and examples at our online resource center:

<https://wiki.netio-products.com/index.php?title=PAB>

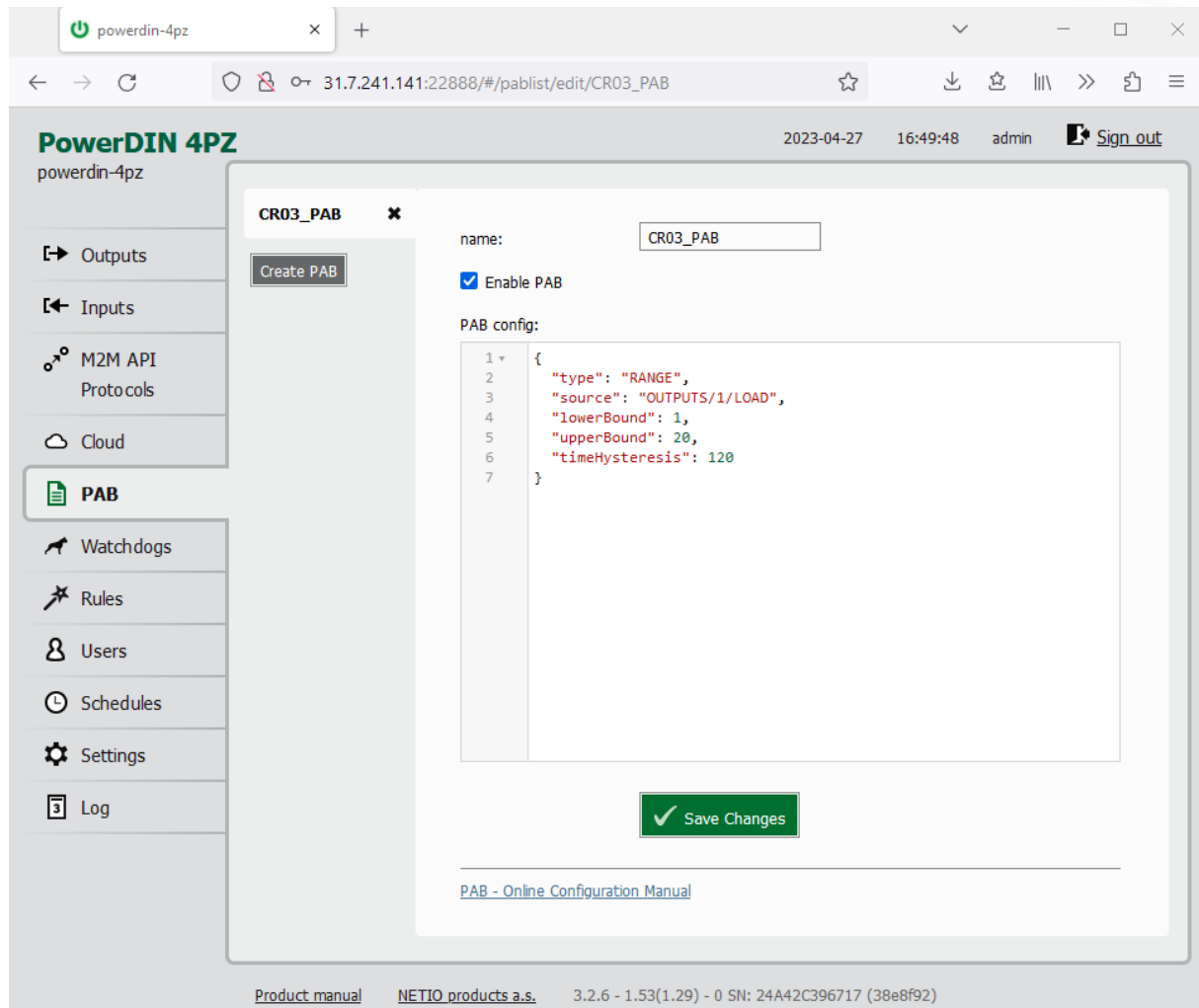

Figure 36 - PAB configuration

name	The name of PAB configuration.
Enable PAB	Check to enable this PAB
PAB config	PAB configuration.
Save Changes	Saves the changes.
Create PAB	Opens a dialog to enter the new PAB configuration.

5.6 Watchdogs

Watchdog is a **Condition & Rules** function periodically pinging to one defined IP address or URL. It's periodically checking reply from defined IP device by ping (ICMP). You can monitor physical presence of the IP device or Internet connectivity. You can use several WatchDog functions in parallel.

Based on each Watchdog state one or several **Rules** can be executed. Each Rule can perform several actions (Set Output, Short Off (restart) output, Toggle output or send Alarm state to the NETIO Cloud service. Based on this Alarm state can NETIO Cloud send email to defined recipient. All Watchdogs are listed in the JSON protocol with their current states. It can be used by 3rd party software.

Each Watchdog function state is the FAIL variable.

- Watchdog Fail = FALSE = ping answer is OK
- Watchdog Fail = TRUE = ping answer not received

Several Watchdogs can be configured and running simultaneously.

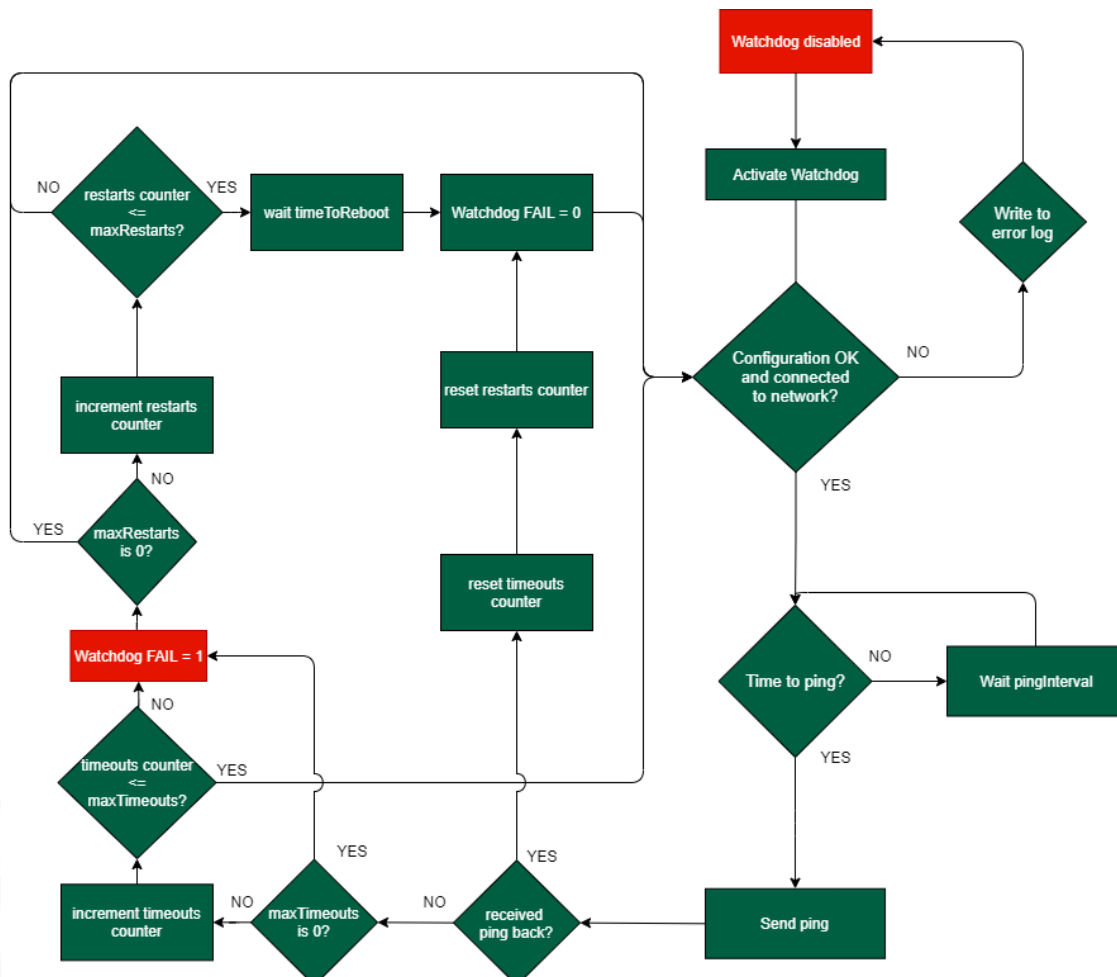

Figure 37 - Watchdogs flow diagram

You will find details and examples at our online resource center:

<https://wiki.netio-products.com/index.php?title=Watchdog>

The screenshot shows the 'default_pinger' configuration page in the PowerDIN 4PZ web interface. The page includes a sidebar with navigation options like Outputs, Inputs, M2M API, Protocols, Cloud, PAB, Watchdogs, Rules, Users, Schedules, Settings, and Log. The main content area shows the configuration for a watchdog named 'default_pinger'. It has a 'Create Watchdog' button, a 'name' field containing 'default_pinger', an 'Enable watchdog' checkbox which is checked, and a 'Watchdog config' field containing the following JSON configuration:

```

1 {
2   "target": "google.com",
3   "pingInterval": 60,
4   "timeout": 5,
5   "maxTimeouts": 3,
6   "timeToReboot": 120,
7   "maxRestarts": 3
8 }

```

At the bottom of the configuration area, there is a green 'Save Changes' button and a link to the 'Watchdog - Online Configuration Manual'. The footer of the page contains the text: 'Product manual NETIO products a.s. 3.2.6 - 1.53(1.29) - 0 SN: 24A42C396717 (38e8f92)'.

Figure 38 - Watchdogs configuration

name The name of Watchdog configuration.

Enable Watchdog Check to enable this Watchdog

Watchdog config Watchdog configuration.

Save Changes Saves the changes.

Create Watchdog Opens a dialog to enter the new Watchdog configuration.

5.7 Rules

Rules are active part of the **Condition & Rules** functions.

Each Rule define the follow-up actions based on current [DI](#) / [PAB](#) / [Watchdog](#) function state. There can be several Rules executed based on one PAB function (switch output if Current > 1000 mA + Send Alert to NETIO Cloud IF Current > 500 mA). One Rule can be executed based on combination of several PAB / WatchDog states.

You will find details and examples at our online resource center:

<https://wiki.netio-products.com/index.php?title=Rules>

The screenshot shows the 'Rules' configuration page in the PowerDIN 4PZ web interface. The page title is 'PowerDIN 4PZ' and the user is logged in as 'admin'. The left sidebar contains navigation options: Outputs, Inputs, M2M API Protocols, Cloud, PAB, Watchdogs, Rules (selected), Users, Schedules, Settings, and Log. The main content area shows a list of rules: Rule1, Rule2, Rule3, and cycling. A 'Create Rule' button is located below the list. The configuration for Rule1 is displayed, including a name field (Rule1), an 'Enable rule' checkbox (checked), and a 'Rule config' field containing the following JSON:

```

1+ {
2+   "conditions": {
3+     "operator": "OR",
4+     "PAB/PAB_RANGE_1/IN": true
5+   },
6+   "actions": {
7+     "OUTPUTS/1/ACTION": 4,
8+     "CLOUD/OUTPUT/1/ALARM": 1
9+   }
10+ }

```

At the bottom of the configuration area, there is a 'Save Changes' button with a green checkmark icon. Below the button, there is a link to the 'Rules - Online Configuration Manual'. The footer of the page contains the following information: Product manual, NETIO products a.s., 3.2.6 - 1.53(1.29) - 0 SN: 24A42C396717 (38e8f92).

Figure 39 - Rules configuration

name	The name of Rule configuration.
Enable Rule	Check to enable this Rule
Rule config	Rule configuration.
Save Changes	Saves the changes.
Create Rule	Opens a dialog to enter the new Rule configuration.

5.8 Users

When several users use the NETIO device, it is advisable to assign them different accounts with the necessary privileges. In the left menu, select **Users**.

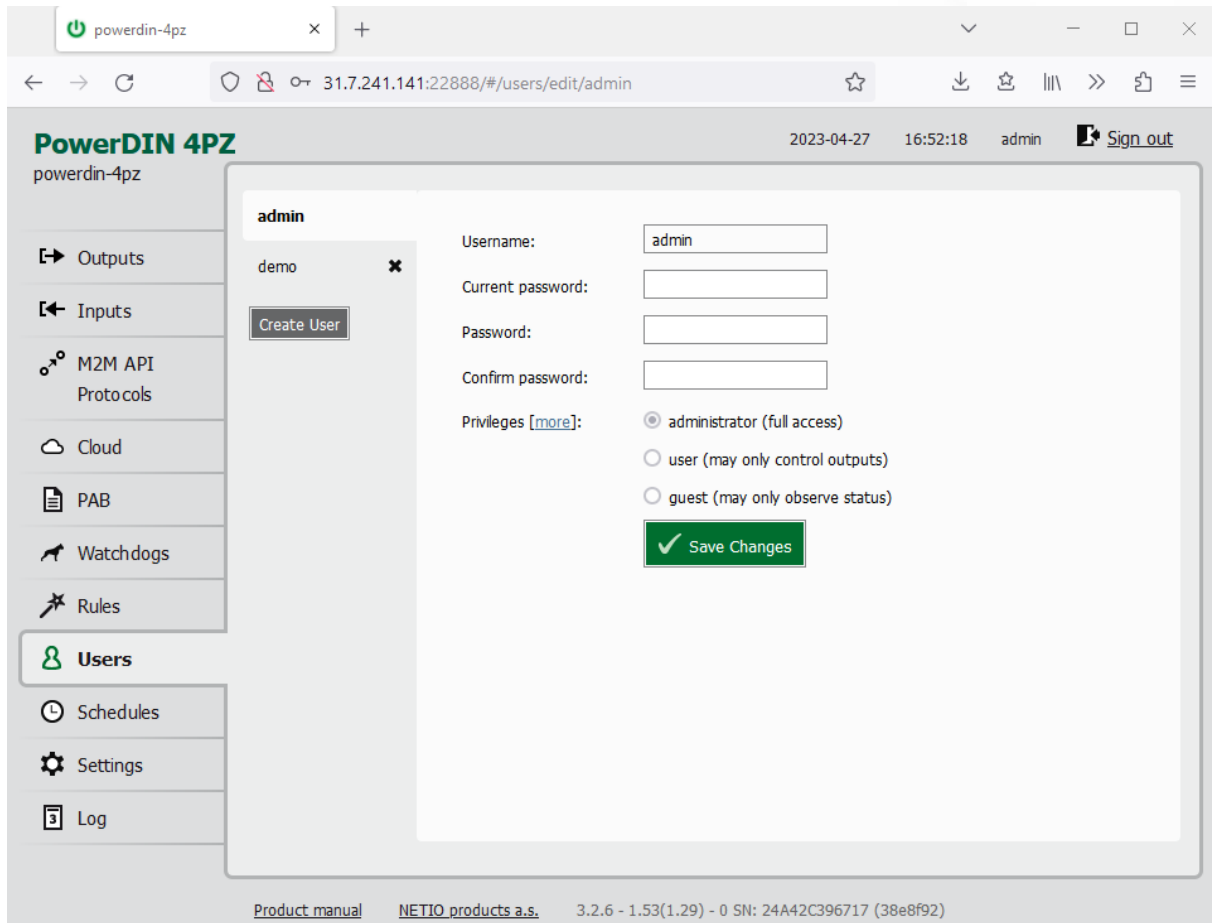

Figure 40 - Adding and managing users

Username	The username. The NETIO device must always have an “admin” account with administrator privileges; this account cannot be deleted or disabled. The device supports up to 5 user accounts. The username must start with a letter and may only contain numbers and letters without accents.
Current password	When changing the password, the current (old) password must be entered.
Password	New password for the given account. The password can be up to 15 characters long and may consist of alphanumeric characters and the following special characters: <code>_,;!*(){}[]#\$%^+~-</code>
Confirm password	Enter the password again.
Privileges	administrator (full access): User with full privileges.

user (may only control outputs): User that can control the outputs but cannot change system settings.

guest (may only observe status): User that cannot change any settings, may only monitor the current output state.

Click “more/less” to display detailed privileges.

Create User	Opens a dialog to enter the parameters of a new user account.
Save changes or Create User	Saves the changes.

Only an administrator or a user with the “manage users” privilege may change the passwords of other users.

Note: User based account can be used for access to NETIO Mobile2 App.

5.9 Schedules

Schedules can specify when should an output be switched on or when is an action valid. To manage schedules, select  **Schedules** in the left menu.

By default, NETIO PowerDIN 4PZ contains one schedule: **Always**. To create a new schedule, click **Create schedule**. Specify the schedule name and set the intervals when the output should be switched on.

Note

For an output to be controlled according to the schedule, the schedule needs to be selected for that particular output at the [Schedule](#) tab in the output configuration.

PowerDIN 4PZ
powerdin-4pz

2023-04-27 16:53:13 admin [Sign out](#)

Always

asdf

[Create Schedule](#)

Name:

	All day	3:00	6:00	9:00	12:00	15:00	18:00	21:00
Monday		00:00 01:50					15:00 16:50	18:30 20:50
Tuesday		01:40 04:50		07:30 10:00		11:40 15:10	17:30 20:40	
Wednesday			04:10 08:10		12:00 14:40		16:20 18:50	
Thursday		02:40 04:50		09:00 – 17:10				
Friday								
Saturday		01:50 04:10		07:10 11:10		13:40 16:20		20:50 24:00
Sunday						13:00 – 19:40		

[Save Changes](#)

The changes of Schedule apply after the next planned change or when Schedule will be enabled for a specific output.

[Product manual](#) [NETIO products a.s.](#) 3.2.6 - 1.53(1.29) - 0 SN: 24A42C396717 (38e8f92)

Figure 41. Adding a custom schedule

A new interval can be quickly created by marking the corresponding slots by clicking and dragging with the **left** mouse button. An existing interval can be shortened or extended by dragging either end of the interval. To delete an interval, click it with the **right** mouse button. To create an interval encompassing an entire day, click the box next to that day in the **All day** column. By clicking and dragging, intervals (including all-day ones) can be created for several days at the same time.

In this quick way, intervals can be created with a granularity of 10 minutes. To specify the times for an existing interval more precisely, click it with the left mouse button to open the start and end time settings. There it is possible to specify the time up to the second. To save the new values, click **OK**. To create a new interval by entering the precise times, click an empty space within the respective day with the **left** mouse button.

The screenshot shows the 'PowerDIN 4PZ' web interface. A modal dialog titled 'Add interval' is open, allowing the user to specify a time range. The 'From' field is set to '06:20' and the 'To' field is set to '06:30'. The background shows a schedule grid for a device named 'asdf' with various time intervals marked.

Day	Interval
Monday	00:00-01:50, 03:00-04:50, 06:00-07:30, 09:00-10:00, 11:40-15:10, 15:00-16:50, 17:30-20:40, 18:30-20:50
Tuesday	01:40-04:50, 07:30-10:00, 11:40-15:10, 15:00-16:50, 17:30-20:40
Wednesday	04:10-08:10, 12:00-14:40, 16:20-18:50
Thursday	02:40-04:50, 09:00-17:10
Friday	
Saturday	01:50-04:10, 07:10-11:10, 13:40-16:20, 20:50-24:00
Sunday	13:00-19:40, 20:50-24:00

Figure 42. Adding an interval with a precision to the second



Deleting a schedule

By deleting a schedule, all Schedulers for specific outputs with this schedule are automatically disabled. The states of the respective outputs are unchanged; however, from that moment on, the outputs are under manual control.

5.10 Settings

NETIO PowerDIN 4PZ can use the Ethernet connection (RJ45) or WiFi connection to network. When the Ethernet cable is connected the WiFi is completely turned off. When the Ethernet cable is disconnected then the WiFi turns automatically on. So Wi-Fi can be the main or only backup connection or not used.

To ensure correct operation as intended, the device settings need to be properly configured. Select  **Settings** in the left menu to display a sub-menu with product settings.

For the Ethernet settings see chapter “Network Configuration / Ethernet”

5.10.1 Wi-Fi

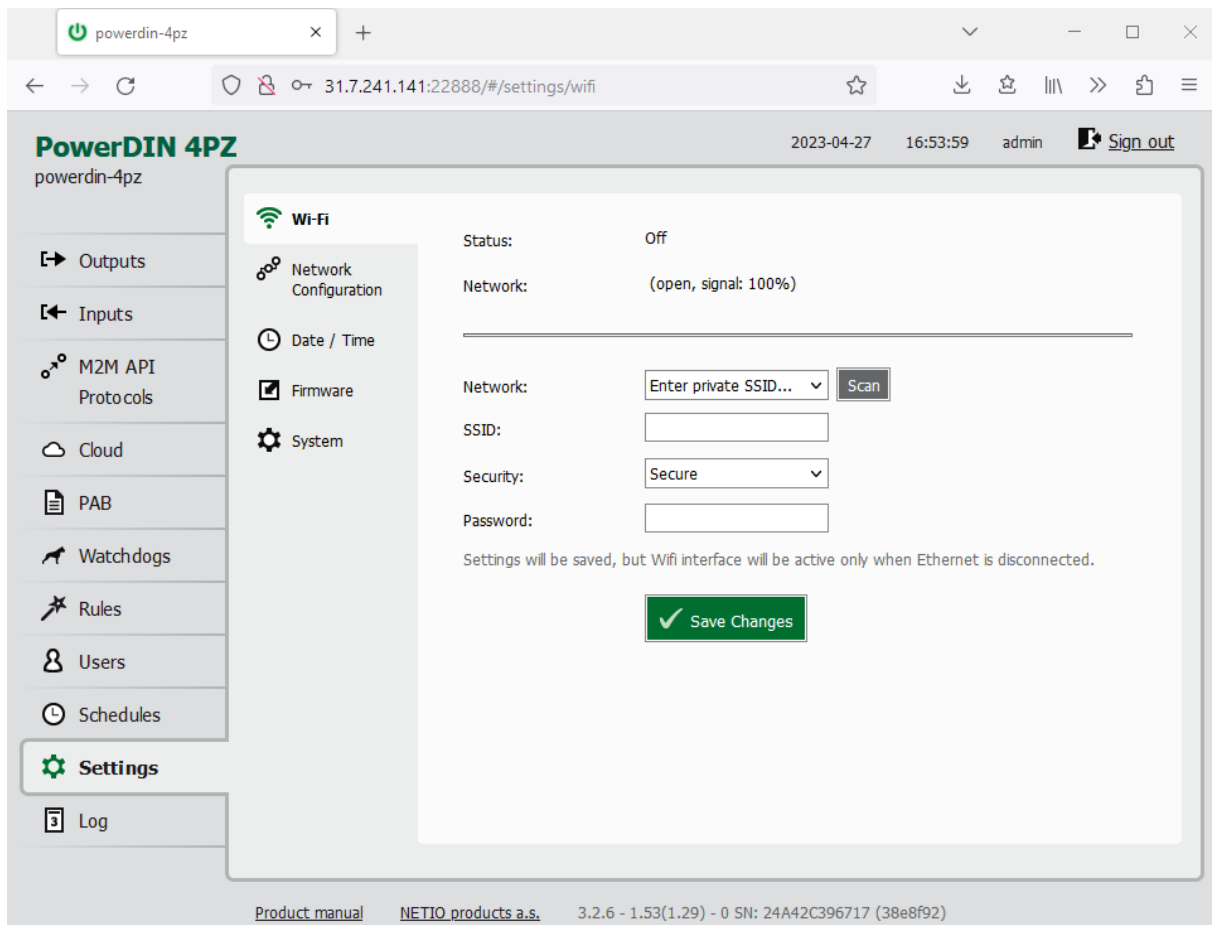

Figure 43 - Wi-Fi settings

Status	Indicates whether the device is connected to (“Connected”) or disconnected from (“Disconnected”) the local network.
Network	Name of the Wi-Fi network to which the device is connected. In parentheses, there is an indication of whether or not the communication is encrypted (“secure”) and of signal strength.
Network [Scan]	From the menu, select a network to connect to. Press Scan to have PowerDIN 4PZ search for Wi-Fi networks in range.

SSID	Enter SSID if selected “Enter private SSID” in Network.
Security	Chose Secure/Open if selected “Enter private SSID” in Network.
Password	Password for connecting to the Wi-Fi network.
Save Changes	Saves the changes. Note: Settings will be saved, but Wifi interface will be active only when Ethernet is disconnected.

5.10.2 Network Configuration

This section allows configuring the IP parameters of the PowerDIN 4PZ network interface, which are essential for correct network operation. One of the options Wi-Fi / Ethernet or both can be configured depending on chosen connectivity.

Wi-Fi

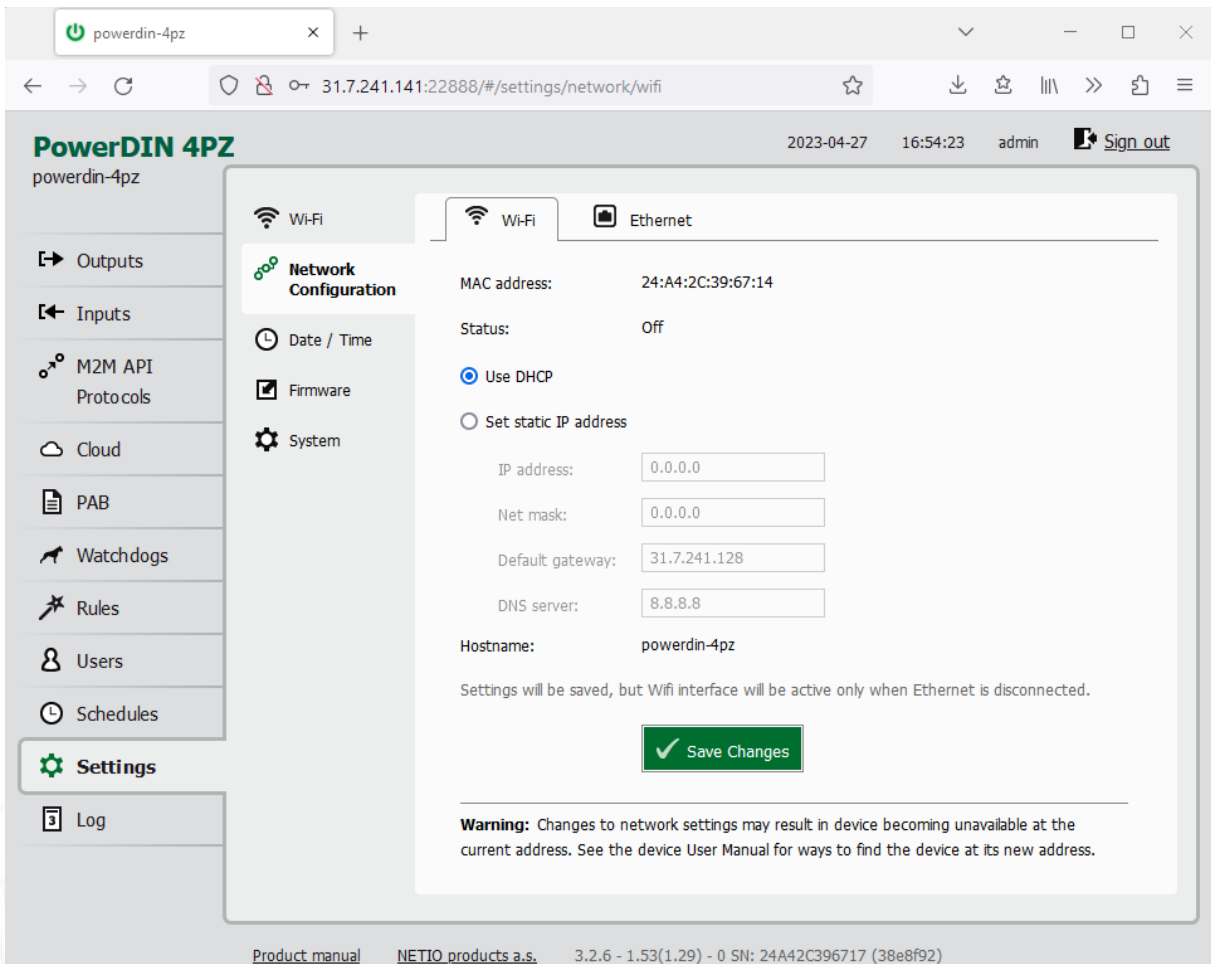

Figure 44 - Network configuration - Wi-Fi

MAC address	Ethernet address of the Wi-Fi network adapter. Unique for each device.
Status	Connection status

Use DHCP

When selected, the device attempts to obtain network configuration from a DHCP server. If your network does not use DHCP, set the parameters statically.

Set static IP address	Manual configuration of network parameters. Select this option if your network does not have a DHCP server.
IP address	Choose an unused IP address in your network's address range.
Net mask	Set the network mask according to your network's address range.
Default gateway	Address of the network gateway. Corresponds to the address of your router's LAN interface.
DNS server	IP address of the domain name server. It is usually the same as the gateway address, as long as the DNS function is enabled on the router. If unsure, enter a public DNS server, such as: 8.8.8.8
Hostname	Name of the device in the local network. It is generated from the Device name (unsupported characters are replaced).
Save Changes	Saves the changes.

**Caution**

After changing the network configuration, it may be necessary to re-discover the NETIO device at its new address. The discovery procedure is described in section [Detecting and configuring the IP address](#).

Ethernet

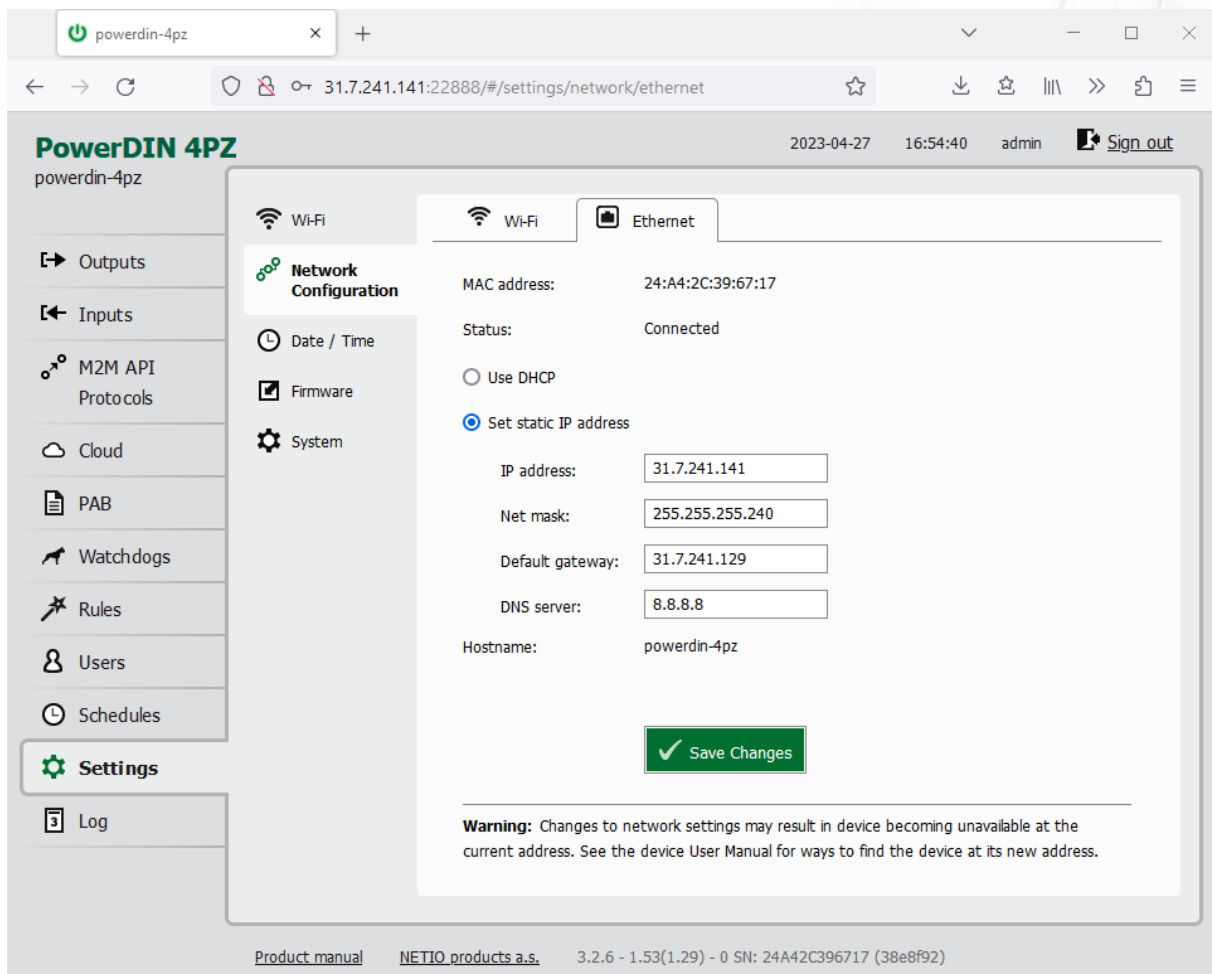

Figure 45 - Network configuration - Ethernet

MAC address	Ethernet address of the Ethernet network adapter. Unique for each device. Also corresponds to the NETIO device serial number.
Status	Connection status
Use DHCP	When selected, the device attempts to obtain network configuration from a DHCP server. If your network does not use DHCP, set the parameters statically.
Set static IP address	Manual configuration of network parameters. Select this option if your network does not have a DHCP server.
IP address	Choose an unused IP address in your network's address range.
Net mask	Set the network mask according to your network's address range.
Default gateway	Address of the network gateway. Corresponds to the address of your router's LAN interface.
DNS server	IP address of the domain name server. It is usually the same as the gateway address, as long as the DNS function is enabled on the router. If unsure, enter a public DNS server, such as: 8.8.8.8

Hostname Name of the device in the local network. It is generated from the Device name (unsupported characters are replaced).

Save Changes Saves the changes.



Caution

After changing the network configuration, it may be necessary to re-discover the NETIO device at its new address. The discovery procedure is described in section [Detecting and configuring the IP address](#) .

5.10.3 Date / Time

In the Settings menu on the left, select  **Date/Time**.

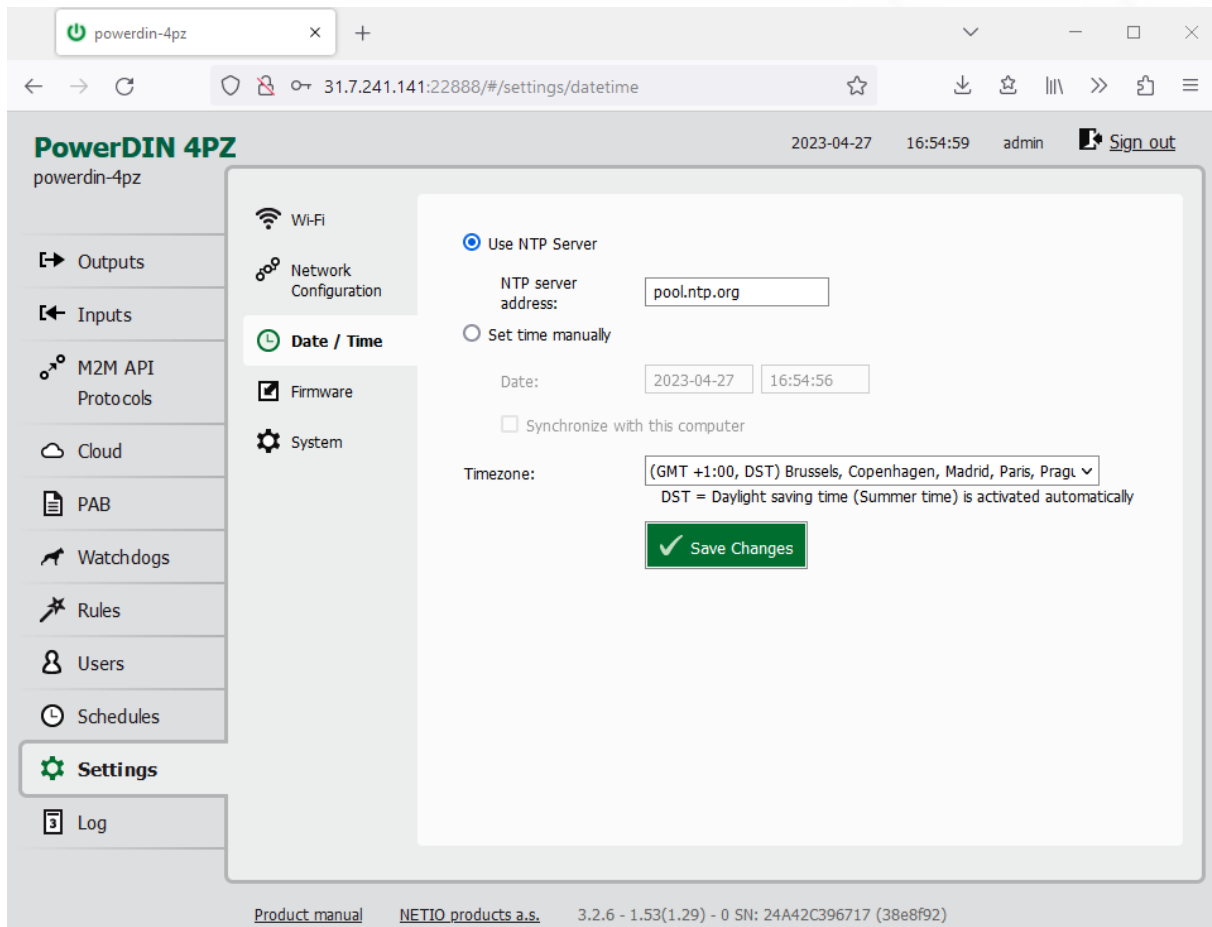

Figure 46 - Date / time settings

Use NTP server

When selected, the device's clock is periodically synchronized with a NTP server. If you do not have your own NTP server in your network, use e.g. tik.cesnet.cz

Set time manually

Select if you do not wish to use a NTP server.

Date

Current date and time on the NETIO device's clock. Can be modified if necessary.

Synchronize with this computer

Check this box to copy the current date and time from your computer to NETIO device's internal clock.

Timezone

Set the time zone to govern the time settings.

Save Changes

Saves the changes.

5.10.4 Firmware

The **Firmware** section allows updating the firmware of your device. The current firmware version is shown in the footer of each page.

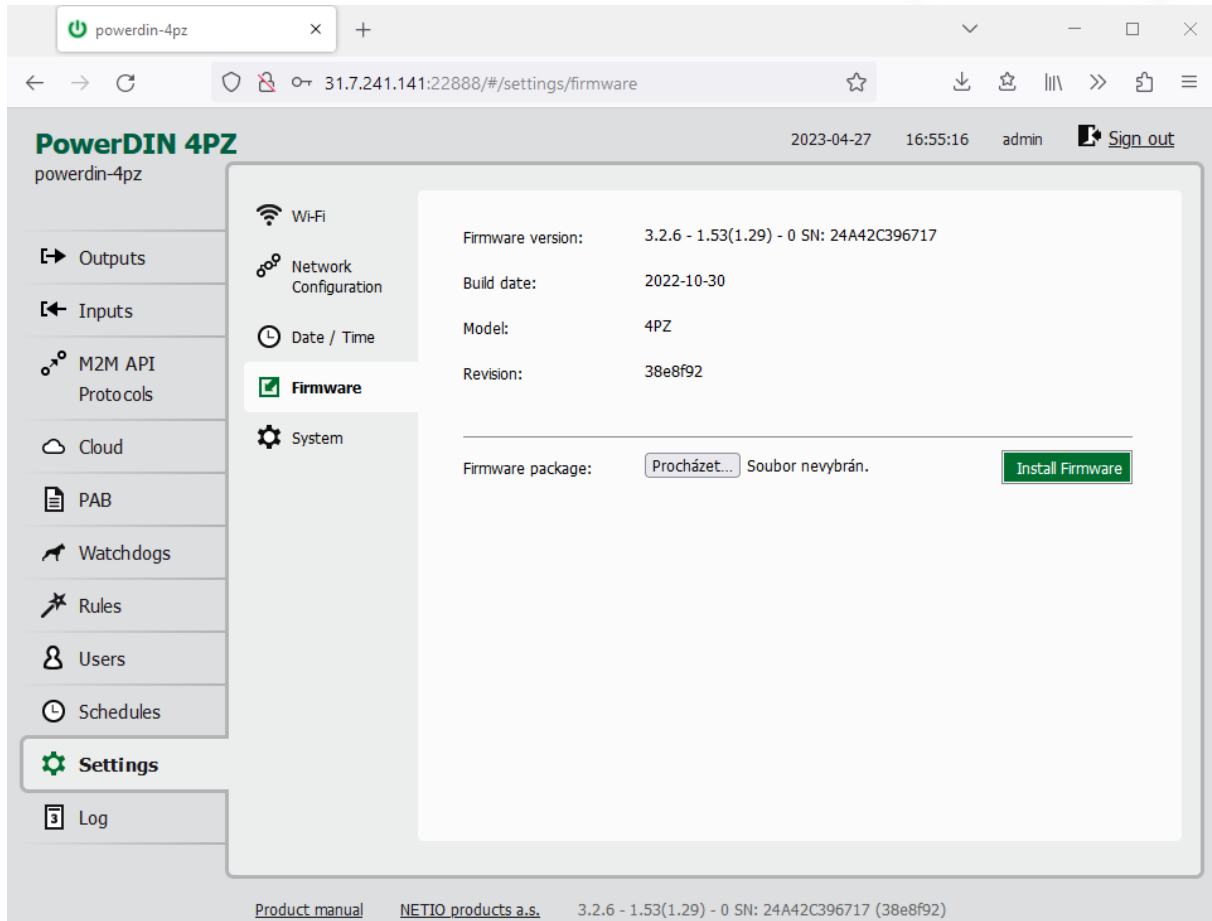

Figure 47 - Details about the installed firmware

Firmware version	Installed firmware version.
Build date	Creation date of the installed firmware version.
Model	Model designation.
Revision	Revision number.
Firmware Package	Click Browse to select a firmware file to install. Then click Install Firmware to start the installation.

Firmware files are available at: <https://www.netio-products.com/en/powerdin-4pz-firmware>

Where to find the right fw?

Go to the product page on our website (link below), select your product and scrool down the page.

<https://www.netio-products.com/en/products/all-products>

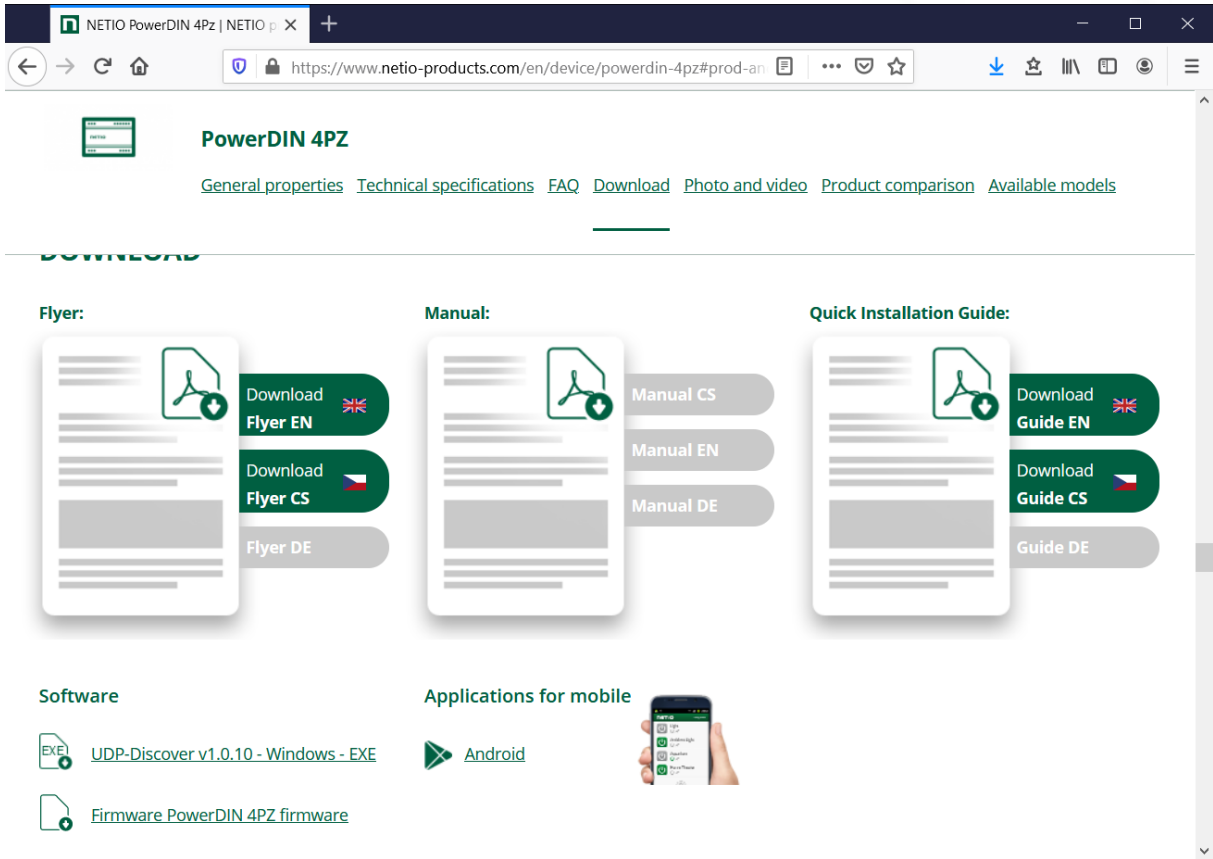

Figure 48 - WEB of NETIO products - Link to Firmware download

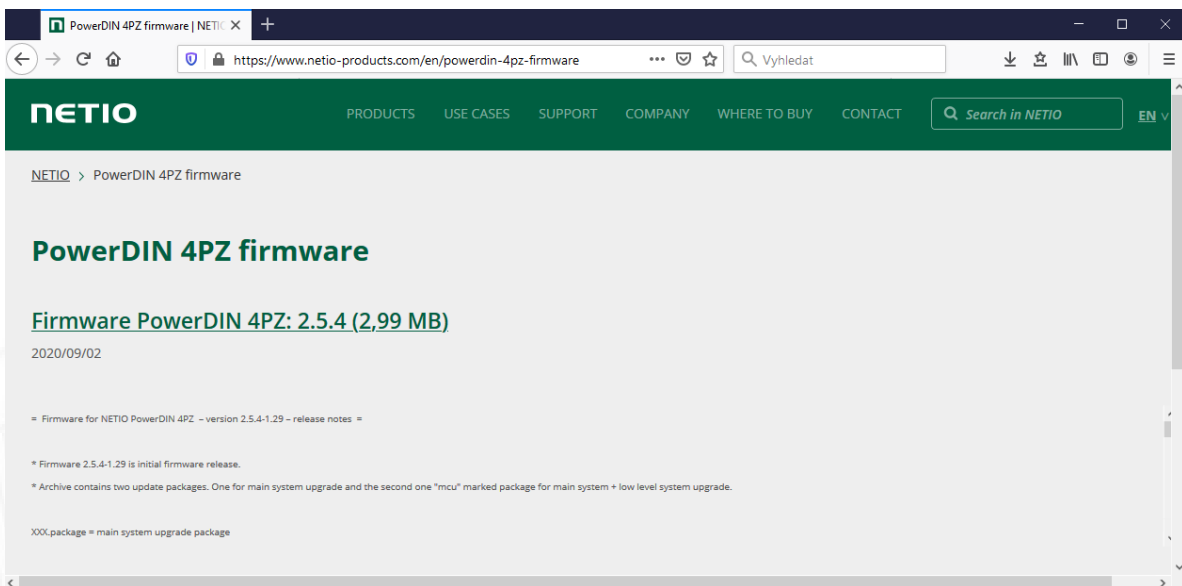

Figure 49 - Firmware download link at the netio-products.com website

**Caution**

Before installing firmware, read carefully the instructions at our website, make sure that you are upgrading from the correct version, and follow the prescribed procedure.

Downgrade to a lower firmware version may cause the device to reset to factory defaults. This will disconnect the device from your Wi-Fi network. For this reason, we strongly discourage from downgrading the firmware remotely, without physical access to the device. Before downgrading the firmware, always consider if it is really necessary and if needed, contact technical support: support@netio.eu

5.10.5 System

This section allows performing basic settings and viewing basic parameters of the device.

The screenshot shows the web interface for a PowerDIN 4PZ device. The browser address bar shows the URL `31.7.241.141:22888/#/settings/system`. The page title is "PowerDIN 4PZ" and the user is logged in as "admin". The left sidebar contains navigation options: Outputs, Inputs, M2M API Protocols, Cloud, PAB, Watchdogs, Rules, Users, Schedules, Settings (selected), and Log. The main content area is titled "System" and includes the following information:

- Uptime:** 2 days 15 hours 29 minutes
- Firmware version:** 3.2.6 - 1.53(1.29) - 0 SN: 24A42C396717 [Upgrade](#)
- Device name:** powerdin-4pz
- HTTP port:** 22888
- Enable Periodic device restart
- Restart period:** 30 minutes, does not affect the Output state
- Save Changes** (button)
- Locate** (button): Blink with status LEDs for 1 minute.
- Reset Power Consumption Counters** (button)
- Restore Factory Defaults** (button)
- Export and import device configuration** section:
 - Export configuration** (button)
 - Configuration file:** Procházet... Soubor nevybrán.
 - Import configuration** (button)

At the bottom of the page, there are links for [Product manual](#), [NETIO products a.s.](#), and the device model and serial number: 3.2.6 - 1.53(1.29) - 0 SN: 24A42C396717 (38e8f92).

Figure 50 - System settings

Uptime	Time since the last restart of the device.
Firmware version	Currently installed firmware version and a link to the Firmware tab.
Device name	Shown in NETIO Discover and under the device logo in the web administration (in the figure above: <i>PowerDIN-EE</i> under the PowerDIN logo in the top left corner).

The device “Hostname” is generated from this Device name (unsupported characters are replaced).

HTTP port	Current http port for webadministration and http based M2M API protocols (XML, JSON, URL API). If the port number is different from 80, it has to be specified in the web browser after the NETIO device IP address, e.g.: 192.168.0.99:888
Enable Periodic device restart	Enables automatic restarting of the device.
Restart period	Specifies the interval for automatic device restarts. The restart does not affect the state of the output.
Debug Log	Adds a DebugLog section with diagnostic values to XML and JSON M2M API.
Save Changes	Saves the changes.
Locate	Identifies a particular device. When clicked, the yellow LED no. 1 starts flashing with pauses.
Reset Power Consumption Counter	Resets the electricity consumption counters.
Factory Reset Defaults	Resets NETIO device to factory defaults. Follow section 3.1 to make the device operational again.
Export and import device configuration	<p>Can be used to back-up and restore device configuration. Do not modify the exported file!</p> <p>“Export configuration” - shows a confirmation dialog for exporting the device configuration and downloading it to your computer.</p> <p>“Browse” - opens a dialog to select a configuration file for import into the device.</p> <p>“Import configuration” - shows a confirmation dialog for importing the device configuration. After the import, the device restarts and the imported configuration takes effect.</p>

5.11 Log

In the left menu, select  **Log**.

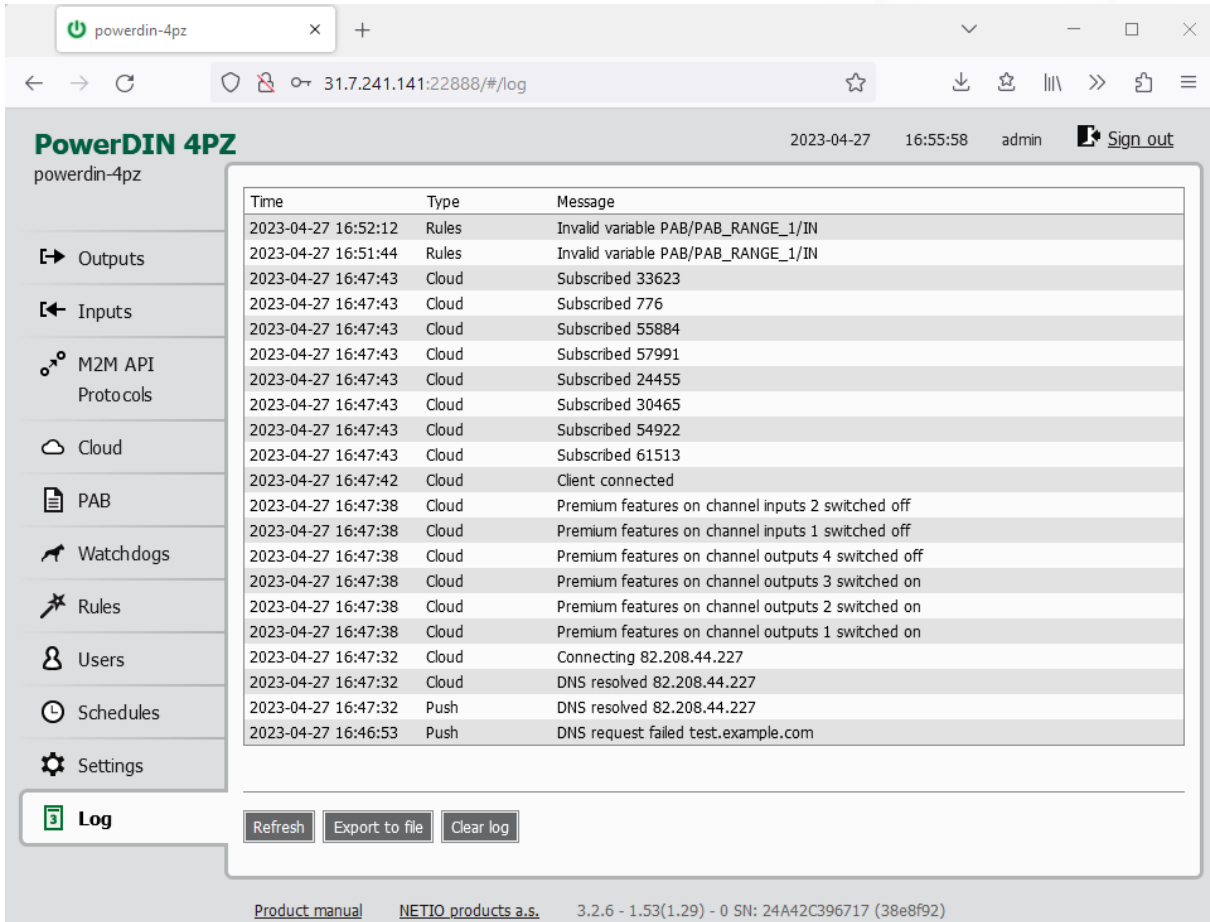

PowerDIN 4PZ 2023-04-27 16:55:58 admin [Sign out](#)

powerdin-4pz

- Outputs
- Inputs
- M2M API Protocols
- Cloud
- PAB
- Watchdogs
- Rules
- Users
- Schedules
- Settings
- Log**

Time	Type	Message
2023-04-27 16:52:12	Rules	Invalid variable PAB/PAB_RANGE_1/IN
2023-04-27 16:51:44	Rules	Invalid variable PAB/PAB_RANGE_1/IN
2023-04-27 16:47:43	Cloud	Subscribed 33623
2023-04-27 16:47:43	Cloud	Subscribed 776
2023-04-27 16:47:43	Cloud	Subscribed 55884
2023-04-27 16:47:43	Cloud	Subscribed 57991
2023-04-27 16:47:43	Cloud	Subscribed 24455
2023-04-27 16:47:43	Cloud	Subscribed 30465
2023-04-27 16:47:43	Cloud	Subscribed 54922
2023-04-27 16:47:43	Cloud	Subscribed 61513
2023-04-27 16:47:42	Cloud	Client connected
2023-04-27 16:47:38	Cloud	Premium features on channel inputs 2 switched off
2023-04-27 16:47:38	Cloud	Premium features on channel inputs 1 switched off
2023-04-27 16:47:38	Cloud	Premium features on channel outputs 4 switched off
2023-04-27 16:47:38	Cloud	Premium features on channel outputs 3 switched on
2023-04-27 16:47:38	Cloud	Premium features on channel outputs 2 switched on
2023-04-27 16:47:38	Cloud	Premium features on channel outputs 1 switched on
2023-04-27 16:47:32	Cloud	Connecting 82.208.44.227
2023-04-27 16:47:32	Cloud	DNS resolved 82.208.44.227
2023-04-27 16:47:32	Cloud	DNS resolved 82.208.44.227
2023-04-27 16:46:53	Push	DNS request failed test.example.com

[Refresh](#) [Export to file](#) [Clear log](#)

Product manual NETIO products a.s. 3.2.6 - 1.53(1.29) - 0 SN: 24A42C396717 (38e8f92)

Figure 51 - Event log

Refresh Reloads the log to show the most recent entries.

Export to file Exports the log in the html format.

Clear log Clears the log records.

The log contains 40 most recent events only and is cleared when the device is restarted.

Sources (types) of log entries:

System	Event generated by the system itself, e.g. WiFi reconnect
WebApi	Event related to a request from the web interface, e.g. User logged in
XML	M2M XML protocol
JSON	M2M JSON protocol
M2M URL	M2M URL API protocol
Modbus	M2M Modbus/TCP protocol
MQTT	M2M MQTT protocol
SNMP	M2M SNMP protocol
Web server	Web server, e.g. Client disconnected
Cloud	NETIO Cloud

6 DECLARATION OF CONFORMITY (RED CE)

Manufacturer: NETIO products a.s.
U Pily 3/103
Address: 143 00 Praha 4, Czech Republic
Product: PowerDIN 4PZ

This declaration of conformity is issued under the sole responsibility of the manufacturer.

Object of the declaration: "NETIO PowerDIN 4PZ controlled and monitored over the WiFi / LAN network".

RED:

The product mentioned above to which this declaration relates is in conformity with the essential requirements and other relevant requirements of the Radio Equipment Directive (2014/53/EU).

The product mentioned above is in conformity with the following standards and/or other normative documents:

EN 55032, EN 55024, EN 61000-3-2, EN 61000-3-3, ETSI EN 301489-1,

ETSI EN 301489-17

LVD:

The product mentioned above to which this declaration relates is in conformity with the essential requirements and other relevant requirements of the Directive 2014/35/EU.

The product mentioned above is in conformity with the following standards and/or other normative documents:

EN/IEC 60950-1 and EN/IEC 62368-1:2014

RoHS:

The product mentioned above to which this declaration relates is in conformity with the essential requirements and other relevant requirements of the Directive 2011/65/EU (restriction of the use of certain hazardous substances in electrical and electronic equipment).

The product mentioned above is in conformity with the following standards and/or other normative documents:

EN 50581: 2012

Czech Republic, Prague, July, 22, 2020

Jan Řehák, Chief of the board



7 Products overview

	LAN (RJ45)	WiFi / Ant.	Power Input / Output Type	Switched outputs	Metered outputs	DI Inputs	Power	Button(s) / Output LED(s)	Industrial features	Power-Up state
PowerPDU 4C (Linux)	2x	-	C14 / C13	4	4	RS232	110/230V / 10A	4 / 4	ZCS, RS232	Yes
PowerPDU 4KS	1	-	C14 / C13	4	4	1x (S0)	110/230V / 10A	1 / 4	ZCS	Yes
PowerPDU 4PS	1	-	C14 / C13	4	-	-	110/230V / 10A	1 / 4	ZVS	Yes
PowerPDU 8QS	1	-	C20 / C13	8	1 + all	1x (S0)	110/230V / 16A	1 / 0	ZVS	Yes
PowerDIN 4PZ	1	Int.	Terminal block	4	2	2x (S0)	110/230V / 16A	1 / 1	ZCS	Yes
PowerBOX 3PF	1	-	DE	3	-	-	230V / 16A	1 / 0	ZVS	Yes
PowerBOX 3PE	1	-	FR	3	-	-	230V / 16A	1 / 0	ZVS	Yes
PowerBOX 3PG	1	-	UK	3	-	-	230V / 13A	1 / 0	ZVS	Yes
PowerBOX 4KF	1	-	DE	4	4	-	230V / 16A	1 / 0	ZCS	Yes
PowerBOX 4KE	1	-	FR	4	4	-	230V / 16A	1 / 0	ZCS	Yes
PowerBOX 4KG	1	-	UK	4	4	-	230V / 13A	1 / 0	ZCS	Yes
PowerCable REST 101F	-	Int.	DE	1	1	-	230V / 16A	1 / 1	ZCS	Yes
PowerCable REST 101E	-	Int.	FR	1	1	-	230V / 16A	1 / 1	ZCS	Yes
PowerCable REST 101J	-	Int.	CH	1	1	-	230V / 10A	1 / 1	ZCS	Yes
PowerCable REST 101G	-	Int.	UK	1	1	-	230V / 13A	1 / 1	ZCS	Yes
PowerCable REST 101S	-	Int.	C14 / C13	1	1	-	110/230V / 10A	1 / 1	ZCS	Yes
PowerCable REST 101Y	-	Int.	(EU plug) / C13	1	1	-	230V / 10A	1 / 1	ZCS	Yes
PowerCable 2PZ	1	Int.	Terminal block	2	-	-	110/230V / 16A	1 / 0	ZVS	Yes
PowerCable 2KZ	1	Int.	Terminal block	2	2	2x (S0)	110/230V / 16A	1 / 0	ZCS	Yes

8 Product features

	Web	HTTPS	Scheduler function	Watchdog function	Local scripting	Telnet	Modbus/TCP	XML	JSON	URL-API	SNMP v1	SNMP v3	Http(s) push XML / JSON	MQTT	MQTT-flex
PowerPDU 4C (Linux)	Yes	Yes	Yes	Ping only	Lua	Yes	Yes	Yes	Yes	Yes	Yes	Yes	-	Yes	-
PowerPDU 4KS	Yes	-	Yes	Ping + Power	C&R	Yes	Yes	Yes	Yes	Yes	Yes	Yes	Yes	-	Yes
PowerPDU 4PS	Yes	-	Yes	Ping	C&R	Yes	Yes	Yes	Yes	Yes	Yes	Yes	Yes	-	Yes
PowerPDU 8QS	Yes	-	Yes	Ping + Power	C&R	Yes	Yes	Yes	Yes	Yes	Yes	Yes	Yes	-	Yes
PowerDIN 4PZ	Yes	-	Yes	Ping + Power	C&R	Yes	Yes	Yes	Yes	Yes	Yes	Yes	Yes	-	Yes
PowerBOX 3Px (E,F,G)	Yes	-	Yes	Ping	C&R	Yes	Yes	Yes	Yes	Yes	Yes	Yes	Yes	-	Yes
PowerBOX 4Kx (E,F,G)	Yes	-	Yes	Ping + Power	C&R	Yes	Yes	Yes	Yes	Yes	Yes	Yes	Yes	-	Yes
PowerCable REST 101x	Yes	-	Yes	Ping + Power	C&R	Yes	Yes	Yes	Yes	Yes	Yes	Yes	Yes	-	Yes
PowerCable 2PZ	Yes	-	Yes	Ping	C&R	Yes	Yes	Yes	Yes	Yes	Yes	Yes	Yes	-	Yes
PowerCable 2KZ	Yes	-	Yes	Ping + Power	C&R	Yes	Yes	Yes	Yes	Yes	Yes	Yes	Yes	-	Yes

C&R = Conditions & Rules